



# LOGISTICS AND WAREHOUSING MANAGEMENT



# Logistics and Warehousing Management

IMMM



© Copyright 2020 Publisher

**ISBN:** 978-93-89795-50-9

This book may not be duplicated in any way without the express written consent of the publisher, except in the form of brief excerpts or quotations for the purposes of review. The information contained herein is for the personal use of the reader and may not be incorporated in any commercial programs, other books, databases, or any kind of software without written consent of the publisher. Making copies of this book or any portion, for any purpose other than your own is a violation of copyright laws. The author and publisher have used their best efforts in preparing this book and believe that the content is reliable and correct to the best of their knowledge. The publisher makes no representation or warranties with respect to the accuracy or completeness of the contents of this book.

# Table of Contents

<b>CHAPTER 1:</b>	An Introduction to Logistics Management .....	1
<b>CHAPTER 2:</b>	Logistics and Supply Chain Management .....	19
<b>CHAPTER 3:</b>	Transportation: Backbone of Logistics.....	33
<b>CHAPTER 4:</b>	Containerisation.....	49
<b>CHAPTER 5:</b>	Container Freight Stations .....	63
<b>CHAPTER 6:</b>	Dry Ports in Logistics Management.....	79
<b>CHAPTER 7:</b>	Introduction to Warehousing .....	95
<b>CHAPTER 8:</b>	Functions of Warehousing .....	109
<b>CHAPTER 9:</b>	Warehouse Location and Design .....	123
<b>CHAPTER 10:</b>	Warehouse Activities and Equipment.....	143
<b>CHAPTER 11:</b>	Health and Safety Issues in Warehousing .....	165
<b>CHAPTER 12:</b>	Warehousing Strategy .....	185

112222

# An Introduction to Logistics Management

## Table of Contents

---

- 1.1 Introduction**
- 1.2 Concept of Logistics Management**
  - 1.2.1 Definition of Logistics
  - 1.2.2 Scope of Logistics
  - 1.2.3 Objectives of Logistics Management
  - 1.2.4 Importance of Logistics Management
    - Self Assessment Questions
- 1.3 Types of Logistics**
  - Self Assessment Questions
- 1.4 Components of Logistics Management**
  - Self Assessment Questions
- 1.5 Logistics Activities in the Manufacturing Organisation**
  - Self Assessment Questions
- 1.6 Role of Logistics in an Economy**
  - Self Assessment Questions
- 1.7 Summary**
- 1.8 Key Words**
- 1.9 Case Study**
- 1.10 Exercise**
- 1.11 Answers for Self Assessment Questions**
- 1.12 Suggested Books and e-References**

**LEARNING OBJECTIVES**

*After studying this chapter, you will be able to:*

- Describe the concept of logistics management
- Explain the scope, objectives and importance of logistics management
- Describe the types and components of logistics management
- Describe the logistics activities in the manufacturing organisation
- Discuss the role of logistics in an economy

**1.1 INTRODUCTION**

In today's highly competitive global business scenario, organisations are compelled to find innovative ways to deliver value to their customers. The changing global market dynamics make an organisation compete with competitors in terms of products, cost, quality and services. This, in turn, has paved the way for a need to develop logistics systems that are more advanced as compared to traditional methods. Over the last two decades, logistics has shifted its focus from a mere operational level to the corporate level. A growing need for effective logistics management that encompasses the whole organisation assists in cost reduction and enhancing service delivery.

Logistics management maximises profit by integrating an organisation with flow of materials, information and funds. The key to a successful logistics management requires an efficient collaboration of activities, cooperation, coordination and information sharing throughout the organisation's supply chain. It plays a crucial role in solving perplexed logistics problems and manage the entire supply chain as a single entity. It is cardinal to an organisation as it is concerned with both materials and information flow. On the one hand, while the materials flow from the supplier to the consumer, on the other hand, information flows from the consumer to the supplier in the form of feedback. It is not just limited to inventory and resource maximisation, but even customer feedback of the product also comes under the scope of logistics. It establishes a link between the manufacturing and various operations of the organisation. Without this crucial link, it would be uphill for organisations to make their products reach the target customers. The Council of Supply Chain Management Professionals (CSCMP) defines logistics management as *that part of supply chain management that plans, implements, and controls the efficient, effective forward and reverse flow and storage of goods, services and related information between the point of origin and the point of consumption to meet customers' requirements*. The CSCMP explains logistics management as the management activities that include inbound and outbound transportation management, fleet management, warehousing, materials handling, order fulfilment, inventory management, demand and supply planning and management of third-party logistics service providers. Logistics also encompasses various aspects of customer service, procurement, planning and scheduling production and packaging. Logistics management comprises all

levels of planning and implementation, whether strategic or operational. Logistics further collaborates functions of marketing, sales, manufacturing and finance, and information technology.

In this chapter, you will study the concept of logistics management along with its scope, objectives and importance. The chapter will also brief you about the types and components of logistics management. Later on, the chapter discusses the logistics activities in the manufacturing organisation and the role of logistics in a country's economy.

## 1.2 CONCEPT OF LOGISTICS MANAGEMENT

Logistics management is an essential component of supply chain management that aims at catering to customer demands. Logistics management involves planning, controlling and implementing of the movement and storage of goods and services from the point of origin to the ultimate customer. It enables organisations to cut down on expenses and bolster customer satisfaction. The genesis of the term 'logistics' was military-based that encompasses how military personnel procured, stored and moved army equipment and supplies. The term is now pervasively used across the business industry, especially by organisations in the manufacturing sectors.

The process of logistics management is initiated from garnering raw materials to the final stage of delivering finished products for customers to avail. Logistics management entails formulating strategy, planning and implementing it to address customers' demand while also considering prevailing market condition. Logistics management collaborates activities, such as raw materials procurement, production process, and distribution of finished products. It aims at providing an organisation competitive and increased product value for fulfilling customers' expectations. It also looks at minimising holding excess of inventory and supply costs.

The five Rs of logistics are as follows:

- Right products
- Right place
- Right time
- Right condition
- Right cost

Some of the elements related to logistics management are as follows:

- It helps in choosing the right supplier for providing transportation facilities.
- It assists in choosing the most effective channel for product distribution.
- It measures the customer and market needs.
- It helps in cutting down on inventory and storage costs.
- It focusses on maximising organisational profits.

A pictorial representation of logistics management is shown in Figure 1:

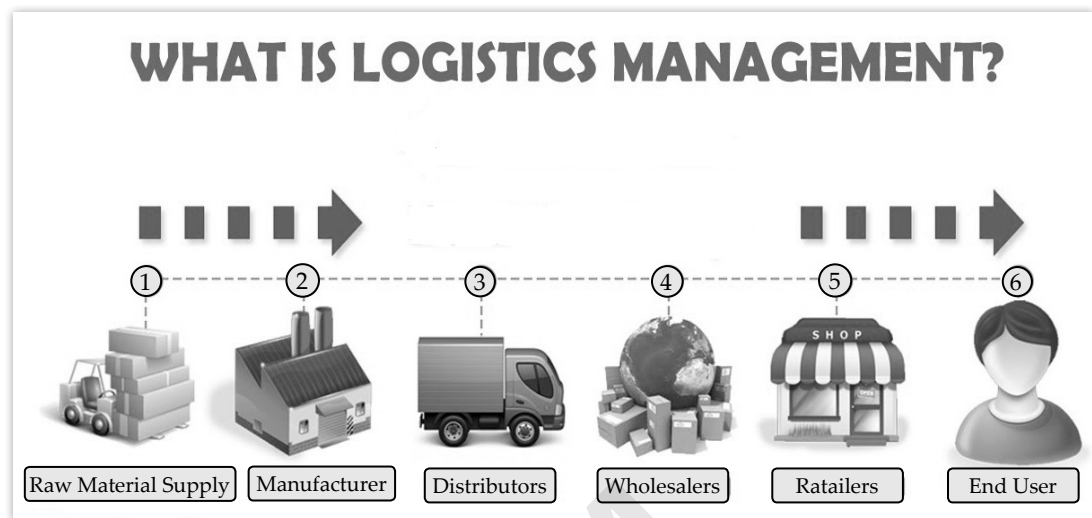

FIGURE 1: Logistic Management

Logistics undertakes the task of safe delivery of the product from one point to another, and, thus, it is responsible for the security of the product. Most logistics organisation take insurance on the products being transported. Logistics comprises material handling, warehousing, transportation and packaging the goods and controlling the inventory. Logistics involves dealing with both finished and unfinished products.

Logistics can affect an organisation in more than one way. If the logistics of the organisation is not efficient enough, it would lead to increased costs and low customer satisfaction. On the other hand, efficient logistics serves to reduce the costs for the organisation and increase the customer service, therefore, helping in increasing the profitability.

### 1.2.1 | DEFINITION OF LOGISTICS

Some of the key definitions of logistics are as follows:

According to **Council of Logistics Management**, "Logistics is the process of planning, implementing, and controlling the efficient, effective flow and storage of goods, services, and related information from point of origin to point of consumption for the purpose of conforming to customer requirements." Note that this definition includes inbound, outbound, internal, and external movements, and return of materials for environmental purposes.

According to **Phillip Kotler**, Market logistics involves planning, implementing and controlling physical flow of material and final (finished) goods from the point of origin to the point of use to meet customer requirements, at a profit.

According to **The Council of Supply Chain Management**, Logistics management is a part of supply chain management that plans, implements, and controls the efficient flow and storage of goods, services, and related information in order to meet the customers' requirements.

According to **Kroon and Vrijens of Erasmus University, Rotterdam**, Logistics management and the activities involved in the reduction, management and waste disposal

and not disposed waste (packaging and products). It implies that goods and services are flowing in the opposite direction to normal logistic activities.

According to **The Council of Logistics Management**, *Logistics is the process of planning and controlling the efficient and effective flow and storage of goods, services and related information from the point of origin to the point of utilisation, as per the customer requirements.*

According to **Logistix Partners Oy, Helsinki, FI**, *Logistics is defined as a business planning framework for the management of material, service, information and capital flows. It includes an increasingly complex information, communication and control systems required in today's business environment.*

According to **Canadian Association of Logistics Management**, *Logistics is the process of planning, implementing, and controlling the efficient, cost-effective flow and storage of raw materials, in-process inventory, finished goods and related information from the point of origin to the point of consumption for the purpose of meeting customer requirements.*

### 1.2.2 | SCOPE OF LOGISTICS

Logistics have always been associated with human society though the scope of logistics has changed over time. The word 'logistics' has originated from the Greek language, which alluded to words such as 'logos' which refers to counting or reasons, 'logistike' referring to the art of calculation. The word 'logistics' also has its source in the French language. In French, 'logistique' covers words such as transport, accommodation or supply of troops, whereas in English context, 'logistics' was used in the field of military.

Logistics management entails each stage of products' physical distribution. Starting from procurement of raw materials, materials handling and storage, managing stock, sales forecasting, transport and storage requirements. Since activities involved in the logistics management are often intricate and demand a high level of specialisation, there is a need for professional staff to manage logistics. For example, the use of forklift trucks, cranes and lifts while handling products at a warehouse can be a dangerous affair. If such equipment are operated by untrained or amateur employees, then can result in serious injury or damage and even prove to be fatal.

The scope of logistics encompasses materials, integration materials purchased as per market demand and moving finished products from genesis to the point of sale. In today's modern world, logistics is of prime importance for an organisation as it deals with delivering products and services whether the product is tangible or intangible. The logistics swiftness and reliability of products contribute immensely to the growth of the nation's internal and external trade. Logistics cost in terms of GDP percentage across the globe is depicted in Table 1:

TABLE 1: Logistics Cost in Terms of GDP Percentage

Country	Logistics Cost in GDP (%)
Korea	16
China	15
Japan	14
India	13

## NOTES

Country	Logistics Cost in GDP (%)
France	12
UK	11
USA	10

### 1.2.3 | OBJECTIVES OF LOGISTICS MANAGEMENT

The primary objective of logistics management is to maintain a smooth flow of materials in a supply chain effectively so as to fulfil the customers' desired level of satisfaction. Logistics management is also involved with providing products and services as and when they are required. The objective of logistics management is to maintain the goals of the organisation by keeping the cost at minimum as possible.

Logistics management involves storage, distribution, warehousing, goods handling, transportation, monitoring and delivery of goods. It also entails planning, organising, managing, coordinating and controlling the flow of goods to ensure that goods reach the right place, at the right time, for the right cost and in the right condition. Logistics management also strives to maintain ethical integrity throughout the organisation. For example, in various instances, personnel responsible for transporting valuable merchandise falsely report theft of missing of merchandise and sell it in the market. It is the responsibility of the logistics department to monitor and control such unethical practices.

The objectives of logistics management are as follows:

- To ensure all the requirements of the customers are met on time
- To coordinate with third-party logistics (3PLs)
- To ensure timely despatch of the products
- To devise policies and procedures for successful implementation of logistics system
- To synchronise business goals with logistics system
- To create and maintain customer support
- To have stable integration among the vendors, service providers and transport carriers
- To provide a competitive edge to an organisation through increased sales and better customer service
- To ensure cost reduction and maximise return from products/services

### 1.2.4 | IMPORTANCE OF LOGISTICS MANAGEMENT

As discussed earlier, logistics management involves planning, implementing and controlling smooth flow of goods. The logistics involve moving goods from the point of origin to the point of consumption to cater to customer needs. Logistics management is a paramount reason for the success of any organisation and bears an impact on the profitability. Logistics management is important for satisfying customer needs and providing top-notch service. It is crucial for every organisation to have a strong knowledge of logistics systems for yielding high profits and be able to deliver customers the most positive experience of the product.

The importance of logistics management for an organisation is as follows:

- **Quality products:** Robust logistics management enables organisations to deliver quality products and services to their customers. Right application of logistics management enables organisations to strive for quality and offer customers improved service in future. When an organisation provides better quality products and services, customers are naturally be inclined to purchase products of that particular organisation. Quality products and services even enable organisations to carve a niche for themselves in the industry.
- **Increases transparency:** Logistics management enables organisations to get an insight into every stage of the product. It provides a scope on the aspect on which the product can improve. Logistics management even provides both historical and real-time data pertaining to the product. The customers' response towards the product can be gauged and if modification to the product is required that may be done within the stipulated time frame. Logistics management also keeps a track of the products while they are en route to delivery from the point of origin. By overlooking the products during their transit acts of thefts, pilferage, spoilage, etc., can be avoided.
- **Increases revenue:** By the use of logistics management, an organisation can identify the weak links either during production phase or in the finished product. An organisation persistently strives to make its product stand out from other products. Logistics management helps an organisation to find out the problem plaguing the product. By making necessary improvements to the product or the production process, the product eventually turns out to be a better one. The product which is complete in all regards will definitely be preferred by the customers. In return, the sale of the product will also spurt and higher revenues will flow in.
- **Enhances goodwill:** When an organisation provides a high-quality product, the customers' first preference will be that product. As the product of that organisation will be preferred over other the brand, the value of the product will also increase. Thus, the goodwill of the organisation will increase in tandem with the sale of the product. The product will create a brand value that will provide the organisation an advantage over competitors. At times, even an ordinary product has a higher demand as the brand it has been associated with.
- **Customer satisfaction:** The key to higher revenue and enhanced goodwill is to ensure customer satisfaction. When customers are satisfied, they will be inclined to buy the product of that particular organisation. If the organisation is able to maintain the quality of the product, then it can retain the customer for a longer time period. Moreover, a satisfied customer is an asset to the organisation. When the satisfaction level of the customer is high, the customer will further create a word of mouth for the organisation and would promote the product of the organisation.
- **On-time delivery:** Logistics management deals with making the product reach the target market so as to meet the customers' demand. Unless the product is not availed by the customer and the advantages of product are not reaped by the customer, there is no use of the product. No matter of how high quality a product is if it is not available at the right time and at the right place, the product is of little value. Logistics management undertakes the responsibility of transporting the product from the point of origin to the point of consumption so that the product can be availed by the customer. Timely delivery of product is an important factor

## NOTES

while considering the planning for distribution and availability of product which is taken care by logistics management.

- **Communication:** Logistics management also deals with disseminating information not only about demand and supply, but also volumes, inventory, prices and movements. Therefore, logistics management has become more involved in sharing requisite information with the organisation system so that the product reaches its destination in its stipulated time. Logistics management also forms as a link between various departments that work in tandem to create the product. Without proper communication channel, the departments will lack harmony in activities and the organisation will be in a state of haywire.

## SELF ASSESSMENT QUESTIONS

1. The objective of logistics management is to maintain a smooth flow of materials in a supply chain effectively so as to fulfil the customers' desired level of satisfaction. (True/False)
2. \_\_\_\_\_ undertakes the task of safe delivery of the product from one point to another, and, thus, it is responsible for the security of the product.

### 1.3 TYPES OF LOGISTICS

The main types of logistics may be listed as follows:

- **Procurement logistics:** It refers to the type of logistics that includes activities such as planning requirements, conducting market research, evaluating purchase decisions, managing suppliers and placing orders. The objective of procurement logistics is to maximise efficiency and minimise costs. It helps retail enterprises in sourcing merchandises from suppliers and transporting the merchandises to the retail stores. The logistics in Walmart, which procures merchandise from different suppliers from a number of geographical locations, is an example of procurement logistics.
- **Production logistics:** It refers to the type of logistics that includes production of goods. It acts as a bridge connecting procurement to distribution logistics. The objective of production logistics is to utilise the available production capacities for producing the goods required in distribution logistics. The process involves planning the layout and production and controlling it. Production logistics helps goods manufacturers to efficiently utilise their production capacity. The logistics system within a production facility that consists of tools such as conveyor belts and robots for moving materials, is an example of production logistics.
- **Distribution logistics:** It refers to the type of logistics that delivers the finished products to the customer. The process involves order processing, warehousing and transportation. Distribution logistics is important because quantities of production vary with time and demand. It involves sending the produced merchandise to the retail stores through distributors and wholesalers. The logistics system of Pepsi that delivers the foods and beverages of the company to the retailers is an example of distribution logistics.
- **After-sales logistics:** It deals with reverse delivery of damaged products from customers to the retailers, delivery of spare parts to the customers and delivery of

products after repair. At times, retailers take back any damaged merchandise sold to the customers or send the defective merchandise to the service centre through after-sales logistics.

- **Disposal logistics:** It removes and recycles the waste produced during the operation of a business. The objective of disposal logistics is to reduce the cost of logistics and enhance the service levels. The logistics system that helps in collecting, carrying and disposing waste materials of a manufacturing plant is an example of disposal logistics.
- **Reverse logistics:** It refers to the type of logistics that helps in reusing products and materials. It also entails the management and sale of excess products as along with the products returned by the customers. For example, companies such as Pepsi and Coca Cola collect empty bottles of their products from retailers for refiling.
- **Global logistics:** This type of logistics governs the logistic flow of products across countries. For example, global logistics helps online retailers, such as Amazon.com, in sourcing and delivering merchandises to different locations throughout the world.
- **Domestic logistics:** It deals primarily with the flow of goods within one country, but may extend across multiple states. For example, Indian retailer, such as Big Bazaar, sources most of its merchandise from domestic suppliers.

#### SELF ASSESSMENT QUESTIONS

3. \_\_\_\_\_ logistics governs the logistics flow of products across countries.
4. The objective of disposal logistics is to increase the cost of logistics and reduce the service levels. (True/False)

## 1.4 COMPONENTS OF LOGISTICS MANAGEMENT

The components of logistics management are discussed as follows:

- **Storage, warehousing and material handling:** These elements are important for a retail enterprise. The merchandises are required to be stored, warehoused and handled in a proper manner. Some of the important aspects of these elements are warehouse location, storage type and material handling equipment.
- **Packaging:** It involves transportation of merchandise, and reduces the possibility of damage caused during transit. For example, if items, such as processed foods are not properly packed, these can perish in transit.
- **Inventory:** It refers to the stock of materials in retail organisations. Retail organisations maintain inventory levels on the basis of sales and demand forecasts.
- **Transportation:** An effective transportation system ensures timely delivery of merchandises from suppliers to the warehouses, from warehouses to the distribution centres and from distribution centres to the retail stores.
- **Information and control:** These are the most important elements in logistics. Retail enterprises need to have access to the real-time information and control over their logistics operations. Large retail enterprises, such as Walmart uses specialised software to keep track of their operations.

NOTES

- **Order processing:** In large organisations, order processing refers to handling voluminous products to make them reach the desired destination. Order processing operations or facilities are generally known as distribution centres. Order processing comprises verifying the order received and checking whether the facility has the required amount of goods. Order processing is a perpetual process which consists of the following:
  - **Picking:** It entails taking and collecting products in specified quantity prior to shipping the orders for customers.
  - **Sorting:** It refers to the process of separating goods as per their destination. It is crucial for sorting products as it eases the shipment of products. If sorting is not done in correct manner, then it will create a mess for shipment team and the order will not reach the target customers.
  - **Package formation:** It is an important part of order processing as it includes weight, label and pack products. The outer packaging should include weight, usage and specification of the product to inform the customer how to use the product. The packaging should explicitly mention the date of manufacturing, batch number, expiry date or best before date, price of product, organisation producing the product, etc.
  - **Consolidation:** It consists of accumulating packed products to loading bays to be transported. At the loading bays, the goods will be gathered where bill of landing and various documents will be prepared. The packaging of goods will also be inspected whether the outer packaging is sturdy enough to bear the loading and unloading of goods. The packaging should also be efficient enough to prevent products from pilferage and spoilage.

The components of logistics management are showcased in Figure 2:

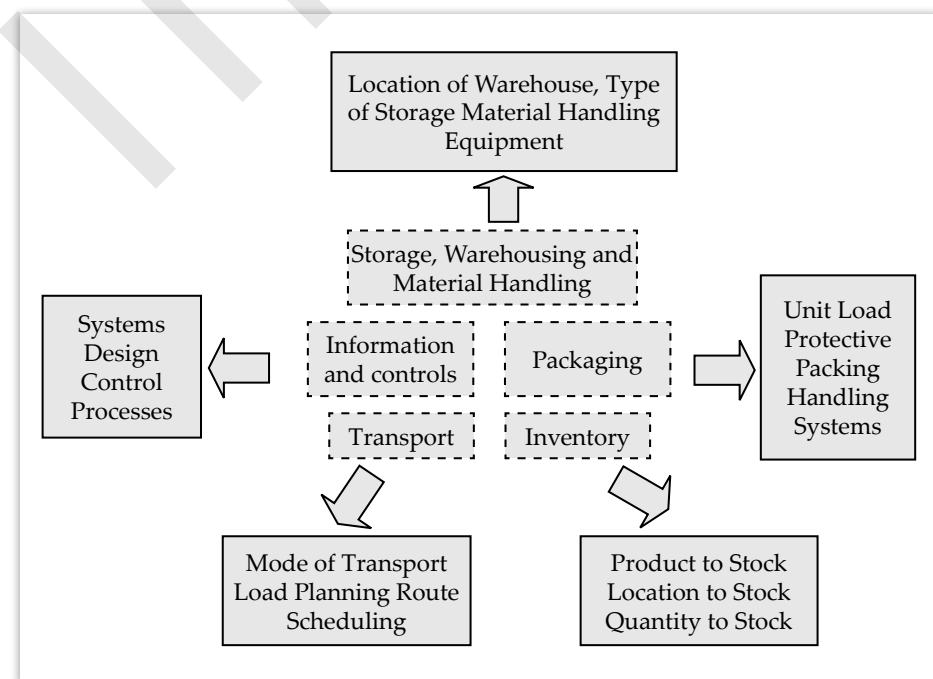

FIGURE 2: Components of Logistics Management

## SELF ASSESSMENT QUESTIONS

## NOTES

5. Effective transportation system cannot ensure timely delivery of merchandises from suppliers to warehouses. (True/False)
6. \_\_\_\_\_ organisations maintain inventory levels on the basis of sales and demand forecasts.

## 1.5 LOGISTICS ACTIVITIES IN THE MANUFACTURING ORGANISATION

Logistics acts like fuel due to which manufacturing organisations are able to run their activities. In the absence of stable logistics, the smooth flow of goods throughout the system would get hampered. With the onset of the twenty-first century, logistics have become a cardinal aspect of material movement fulfilling consumers' demand. The entire global economy is interlinked via the Internet which has raised the bar of customer expectations for quick product delivery. Formulating logistics strategies that meets customer desires requires manufacturing organisations to dwell insight into physical location of warehouses and the implementation of advanced logistical software to receive customers' requests in real time rather than days. Logistics strikes a fine balance between the demand and supply of products; it comprises activities starting from procurement of raw materials to giving them the shape of finished goods. Logistics assists in providing products to the customers at the right place and at the right time. Logistics infuses lifeline in manufacturing organisations. It galvanises the entire machinery of manufacturing organisations to ensure smooth running of operations.

Streamlined logistics activities even cut down operational costs, satisfy customers and strengthen relationship with both customers and suppliers. Logistics form an important cog in the wheel for manufacturing organisations without which it would be tough for them to tread. Logistics disentangles the complexities of transportation, shipping and receiving, import and export operations, warehousing, inventory management, purchasing, production planning and customer service.

Logistics activities involved in the manufacturing organisations are as follows:

- **Order taking:** Order taking is fundamental to any transaction between the manufacturing organisation and supplier. Order taking comprises the requisite details such as the specifications of the product. Undertaking logistics activities assures that orders are processed in time and as per the terms. Logistics ensure that orders are fulfilled in time so that needs of customers are met. Timely delivery of orders will enhance the customers trust in the organisation.
- **Inventory:** Proper inventory management ensures seamless supply of products but also cuts down on storing costs. Logistics ensures that there is neither excess of products in inventory nor deficit. Haphazardly managed inventory will lower the profits of manufacturing organisations and may even lead to pilferage in the stocks.
- **Warehouse:** A warehouse can be deduced as a spinal cord of manufacturing organisation a place for various logistics activities. An ideal manufacturing

## NOTES

organisation can be measured by its efficacy in warehousing decisions. A warehouse should be located near a point of consumption and should be able to store sufficient products in case of unforeseen demand of products. Factors such as warehouse location, size, layout and design play a crucial role in logistics activities of manufacturing organisations.

- **Transportation:** Transport is the single most important aspect of logistics activities in manufacturing organisations. The physical movement of finished products is pivotal as unless products do not reach the target customers, the demand or customer satisfaction cannot be fulfilled. Transportation ensures delivery of products from the point of origin to the point of consumption. Timely availability of products is of prime importance as only then the reason to manufacture a product will be attained.
- **Material handling:** Material handling is also an important logistics activity for manufacturing organisations which need to be meticulously looked after. Inefficient material handling may result in product damages, delays, pilferage, spoilage, etc. Introduction of automation in material handling has proved to be a boon for manufacturing organisations. Automation ensures smooth volume, speed and the level of service in material handling.
- **Packaging:** Packaging is a logistic activity that is a must for every manufacturing organisation. Packing ensures that during physical distribution of a product they do not get affected or lose their quality. Correct packaging assists in minimising damage to finished products and saving the products from spoilage, pilferage and thefts. Packaging also provides customer with the specifications of the product such as its weight, date of manufacturing, name of manufacturing organisation, ideal time for product consumption, price, etc.
- **Information sharing:** Logistics helps in exchange of information throughout the organisation and is of great importance to deliver quality service to customers. Information sharing tools are constantly used by organisations to identify access, store, scrutinise and archive important data which can help organisations to foresee demand. Effective information sharing will ensure integration of various activities and coordination among departments of organisation. In the absence of proper information, sharing will lead to hotchpotch in activities of organisation and may even increase unwarranted costs.

## SELF ASSESSMENT QUESTIONS

7. Streamlined logistics activities even cut down operational costs, satisfies customers and strengthen relationship with both customers and suppliers. (True/False)
8. Logistics activities start from \_\_\_\_\_ of raw materials to giving them the shape of finished products.

## 1.6 ROLE OF LOGISTICS IN AN ECONOMY

Logistics plays an important role in an economy. Logistics includes the smooth flow of products and services across the manufacturing and services sectors. Many

organisations heavily rely on logistics to keep their activities running smoothly. Nowadays, organisations have viable infrastructure and record-keeping, which continues to make advancement with sophistication of technology. With the passage of time, the importance of logistics has increased manifold. In fact, logistics has encompassed factors such as warehousing, transporting, information, etc., under its ambit. Through the use of logistics, organisations have expanded their roots or network to a slew of cities and logistics is a key employment generator across wide geographical locations. Technology sector of the economy is one that is reaping the benefiting of surge in logistics. A viable organisation will collaborate all the logistics function into a digital strategy. The organisations can track orders, shipment, transporting vehicles, products moment, etc., to get a proper visibility and improve the weak links in the system.

According to **Peter Drucker**, American management consultant, educator and author, *Logistics is one of the last frontiers of opportunity for organisations wishing to improve their corporate efficiency.*

In the modern context, trend of third-party logistics(3PL) is also gaining momentum. In a span of ten years, logistics has witnessed a substantial growth throughout the globe.

Logistics industry is now stated to be worth £8.54 million and \$174 billion in the European Union. This bears testimony that logistics has created a plethora of employment opportunities for transporters, warehouse facility owners, brokers for freight, etc. To better understand logistics, consider that the products that had to be made available to the consumer did not reach the destination on time. If the goods do not reach the desired destination at the correct time and in the right quantity, then no transaction will be done. Hence, no economic activity will take place which will affect the economy of the country.

Logistics manages the efficient forward and reverse flow of products and services from the point of origin to the ultimate recipient. This further infers that logistics bears an impact on the movement of goods and how swiftly products reach the target consumer. In this manner, logistics enables organisations to gain a competitive edge over their competitors.

It is a service for which organisations spend a lot of money, thus generating employment and contributing to the gross domestic product. Logistics also enables the flow of many economic transactions. For example, if the products do not reach the retail stores on time or in the right condition or in the right quantity, the customer will not be able to buy them. If there is no sale, the economic activity will be affected. By facilitating the economic transaction flow, logistics enables the growth of commerce, thus boosting the economy.

Logistics adds value to the organisation by fulfilling the needs of the customers in terms of time and place of availability of the product. The logistics function in an economy aims to contribute to a business in the following ways:

- It ensures high customer service levels.
- It maintains high-quality product delivery.

NOTES

- It helps minimise costs for transportation of products.
- It facilitates to have flexibility and swiftness in changing market environment.
- It assists to maintain a balance between the quality of service and low costs.

SELF ASSESSMENT QUESTIONS

9. Logistics helps in maintaining high customer service levels. (True/False)
10. Logistics also enables the flow of many \_\_\_\_\_ transactions.

**1.7 SUMMARY**

- Logistics management maximises profit by integrating organisations flow of materials, information and funds.
- The key to successful logistics management requires efficient collaboration of activities, cooperation, coordination and information sharing throughout the organisations supply chain.
- Logistics management plays a crucial role in solving perplex logistics problems and to manage the entire supply chain as a single entity.
- The genesis of the term 'logistics' was military-based, that encompasses how military personnel procured, stored and moved army equipments and supplies.
- Efficient logistics would serve to reduce the costs for the organisation and increase the customer service, thus increasing profitability.
- The logistics swiftness and reliability of products contribute immensely to the growth of the nation's internal and external trade.
- An effective transportation system ensures timely delivery of merchandises from suppliers to the warehouses, from warehouses to the distribution centres and from distribution centres to the retail stores.
- The packaging of goods will also be inspected whether the outer packaging is sturdy enough to bear the loading and unloading of goods.
- The primary objective of logistics management is to maintain a smooth flow of materials in a supply chain effectively so as to fulfil the customers' desired level of satisfaction.
- It is the responsibility of the logistics department to monitor and control unethical practices while transporting valuable goods.
- It is crucial for every organisation to have a strong knowledge of logistics systems for yielding high profits and be able to deliver customers the most positive experience of the product.
- When a customer is satisfied, he will be inclined to buy the product of that particular organisation and if the organisation is able to maintain the quality of the product, it can retain the customer for a longer time period.

- Logistic management also forms as a link between various departments that work in tandem to create the product. Without proper communication channel, the departments will lack harmony in activities and the organisation will be in a state of haywire.
- Domestic logistics deals primarily with the flow of goods within one country, but may extend across multiple states.
- Logistics infuses lifeline in manufacturing organisation, it galvanises the entire machinery of manufacturing organisation to ensure smooth running of operations.
- Streamlined logistics activities even cut down operational costs, bolsters relationship and satisfaction of customers.
- A warehouse should be located near a point of consumption and should be able to store sufficient products in case of unforeseen demand for products.
- Logistics form an important cog in the wheel for manufacturing organisations without which it would be tough for them to tread.
- Information sharing tools are constantly used by organisations to identify access, store, scrutinise and archive important data which can help organisations foresee demand.
- In the modern context, trend of third-party logistics (3PL) is also gaining momentum. In a span of ten years, logistics has witnessed a substantial growth throughout the globe.
- Logistics has created a plethora of employment opportunities for transporters, warehouse facility owners, brokers for freight, etc.

## 1.8 KEY WORDS

- **Logistics management:** It involves planning, controlling and implementing the smooth movement and storage of goods and services from the point of origin to the ultimate customer.
- **Procurement logistics:** It refers to the type of logistics that includes activities such as planning requirements, conducting market research, evaluating purchase decisions, managing suppliers or placing orders.
- **After-sales logistics:** It deals with reverse delivery of damaged products from customers to the retailers, delivery of spare parts to the customers and delivery of products after repair.
- **Inventory:** It refers to the stock of materials in retail organisations. Retail organisations maintain inventory levels on the basis of sales and demand forecasts.
- **Packaging:** It involves transportation of merchandise and reduces the possibility of damage caused during transit.

## 1.9 CASE STUDY: LOGISTICS AT WALMART

Logistics is one of the fundamental factors for success of a retail organisation. Nowadays, spike in the level of competition among retailer organisations has

## NOTES

waged a price war in the industry. As a result, a majority of retail organisations are constantly trying to reduce operational costs and providing finished goods at low prices to customers. Therefore, many retail organisations are sourcing materials from different global sources from which these materials are available at cheap rates. Established retail organisations such, as Walmart, ship agricultural products from India, China and Brazil. Managing a global logistical network is a highly intricate task. It involves managing thousands of suppliers from wide geographical locations along with managing the logistics networks, warehouses, storage facilities, transport systems, etc.

For example, a retail organisation like Walmart owns about 3,000 long-haul trucks and 12,000 trailers for the transportation of materials. On the other hand, Walmart's competitors depend on outsourcing the transportation of materials. Walmart efficiently utilises information technology in increasing the effectiveness of its logistics activities. A number of distribution centres of retail organisations are linked via advanced information technology tools to ensure viable coordination.

A highly effective logistical system of Walmart has enabled it to source materials globally. It has helped Walmart keep the operational costs low and deliver its promise of making finished goods available at low prices. Highly efficient logistics is the prime reason behind the highly satisfied customers of Walmart.

### QUESTIONS

1. How has logistics helped Walmart?  
(**Hint:** By effective logistical system, Walmart has reduced operational costs and provided products at low prices.)
2. What is the importance of logistics in achieving customer satisfaction?  
(**Hint:** Providing finished goods at low prices and at the right time.)
3. What is the reason behind price war among retail organisations?  
(**Hint:** High level of competition and advancement in logistics.)
4. Where does Walmart procure its materials from?  
(**Hint:** Walmart procures its materials from India, China and Brazil at cheap rates.)
5. How is Walmart so efficient in its logistic function?  
(**Hint:** Walmart owns about 3,000 long-haul trucks, 2,000 trailers and utilises information technology for logistics activities.)

### 1.10 EXERCISE

1. Describe the concept of logistics management.
2. What are the objectives and importance of logistics management?
3. What is the scope of logistics?
4. Discuss the role of logistics in an economy.
5. Describe various types of logistics.

**1.11 ANSWERS FOR SELF ASSESSMENT QUESTIONS**

NOTES

Topic	Q. No.	Answer
Concept of Logistics Management	1.	True
	2.	Logistics
Types of Logistics	3.	Global
	4.	False
Components of Logistics Management	5.	False
	6.	Retail
Logistics Activities in the Manufacturing Organisation	7.	True
	8.	procurement
Role of Logistics in an Economy	9.	True
	10.	economic

**1.12 SUGGESTED BOOKS AND E-REFERENCES****SUGGESTED BOOKS**

- Swaroop, P. (2014). *Logistics Management*. New Delhi: Anmol Publications.
- Sople, V. (2012). *Logistics Management*. Pearson India.

**E-REFERENCES**

- Logistics Management: Concept, Significance and Key Activities. (2019). Retrieved 12 September 2019, from <http://www.yourarticlelibrary.com/business/logistics-management/logistics-management-concept-significance-and-key-activities/69534>
- What is Logistics Management? - Definition from Techopedia. (2019). Retrieved 12 September 2019, from <https://www.techopedia.com/definition/13984/logistics-management>

112222

# Logistics and Supply Chain Management

## Table of Contents

---

- 2.1 Introduction
- 2.2 Concept of Supply Chain Management
  - 2.2.1 Definition of Supply Chain Management
  - 2.2.2 Objectives of Supply Chain Management
  - 2.2.3 Importance of Supply Chain Management
    - Self Assessment Questions
- 2.3 Role of Logistics in Supply Chain Management
  - Self Assessment Questions
- 2.4 Difference between Logistics and Supply Chain Management
  - Self Assessment Questions
- 2.5 Summary
- 2.6 Key Words
- 2.7 Case Study
- 2.8 Exercise
- 2.9 Answers for Self Assessment Questions
- 2.10 Suggested Books and e-References

**LEARNING OBJECTIVES**

*After studying this chapter, you will be able to:*

- Discuss the concept of supply chain management
- Explain the objectives of supply chain management
- Elucidate on the importance of supply chain management
- Describe the role of logistics in supply chain management
- Differentiate between logistics and supply chain management

**2.1 INTRODUCTION**

In the previous chapter, you studied about the concept of logistics management. The chapter also described the scope, objectives and importance of logistics management. Further, the chapter outlined the types and components of logistics management. The chapter explained the logistics activities in the manufacturing organisation and the role of logistics in a country's economy.

Supply Chain Management (SCM) connects suppliers to customers by providing products, services and information, and offering value-added services. It is a network of transportation and warehousing processes that ensures procurement, distribution, and movement of materials from the point of origin to the point of consumption. The chain of activities and processes that ensures the movement of a product from its raw stage, through value-addition, to the final customer is described as a supply chain.

The objective of a supply chain is to ensure that the right product reaches the right customer, in the right condition, at the right time and at the right price. A supply chain forms a web between the organisation and suppliers to manufacture and physically distribute products or services. Various individuals or bodies that fall under the supply chain web are producers, vendors, warehouses, transportation organisations, distribution centres, retailers, etc. SCM deals with providing goods and services beyond domestic boundaries. For example, a customer in India is out for shopping and visits a shopping mall for purchasing clothes. Upon entering the mall, the customer picks up a piece of cloth and while taking a look at it, the customer notices that the label of cloth reads 'Made in China'. Though the customer hails from India, but the product made in China is available here. This is possible due to the advent of SCM that provides products from one part of the world to the other. SCM has enabled organisations to procure materials from suppliers from different parts of the continent and sell the finished products anywhere on the earth. The term 'supply chain management' first surfaced in the public platform when Keith Oliver, a consultant at Booz Allen Hamilton, used it during an interview in 1982 with the Financial Times. In the late 1990s, the term gained prominence as a management buzzword and organisational managers began to use it more often. Originally supply chains comprised a slew of activities pertaining to the flow and transformation of raw materials into finished products to be availed by the customers.

In this chapter, you will study the concept of supply chain management. The chapter also describes its objectives and importance. Further, the chapter also explains the role of logistics in supply chain management. At last, the chapter enlists the differences between logistics and supply chain management.

## 2.2 CONCEPT OF SUPPLY CHAIN MANAGEMENT

Supply Chain Management (SCM) is referred to as synchronisation of various processes. The processes entail from connecting with suppliers who are responsible for providing products, services and information so that quality product is availed by the customers. It is a network of transportation and warehousing processes that ensures the procurement, distribution and movement of materials from the point of origin to the point of consumption. Supply chain is an integral part of the organisation as it ensures the product is readily available at the apt time at the point of consumption. In today's context, the supply chain forms the backbone of the organisation without which it would be arduous for organisations to survive. Globally, organisations are expanding their reach beyond international boundaries and redefining the manner in which demand and supply are handled.

A network of different companies engaged in producing, handling and/or distributing a particular product is known as a supply chain. An efficient supply chain benefits customers by reducing the incidence of stockouts and providing the assortment of merchandise as required. This, in turn, leads to higher sales, higher inventory turnovers and lower markdowns for retailers.

Every organisation aims to satisfy its customers in the best possible manner. In order to serve customers better, an organisation needs to make timely and undisruptive availability of products and services. Organisations need to formulate that SCM resources, raw materials, and components are gathered and organised for producing finished products to be delivered to end customers on time. Effective SCM makes sure that products are delivered to customers on time by smooth flow of goods and related information. SCM endeavours the profitable progress of organisations by timely processing of customer orders and meeting their expectations.

Logistics is that part of the supply chain process that plans, implements and controls the efficient, effective storage and flow of goods, services and related information from the point of origin to the point of consumption to meet customer requirements. SCM includes logistics but has a more comprehensive and strategic perspective, including inventory management and vendor relations. It may also include new product development.

There are three decision phases of SCM which are as follows:

1. **Design:** In this phase, an organisation makes decisions related to the structure of the supply chain network for the present as well as the future. These are usually long-term decisions as they cannot be altered easily in short periods. These decisions can be choosing the mode of supply chain (internal or external), selecting the location of a plant and warehousing facilities, determining products to be stored at different locations, defining processes to be performed at each stage of supply chain, identifying the modes of transportation and the information system to be utilised, and so on.
2. **Plan:** This phase involves planning for a quarter to a year. The aim behind planning is to generate the maximum supply chain surplus over a period based on the constraints identified during the design phase. The planning of the supply chain begins with the forecast of demand for products in the market in the coming year.

## NOTES

The planning phase involves deciding markets to be supplied, the subcontractors to be used for manufacturing, the inventory policies to be followed, marketing and promotional strategies to be adopted, etc. During the planning phase, a number of factors need to be considered, such as change in demand and level of competition.

3. **Operation:** In this phase, supply chain configuration is fixed and planning policies are established. These decisions are made either on a daily or a weekly basis. Operational decisions are mainly customer-oriented and include the following:
- To decide on the allocation of inventory or production to individual orders
  - To set the date for customer order fulfilment
  - To generate pickup lists at a warehouse
  - To allocate the order to a shipment
  - To define delivery schedules
  - To replenish orders

A graphical representation of a supply chain flow is depicted in Figure 1:

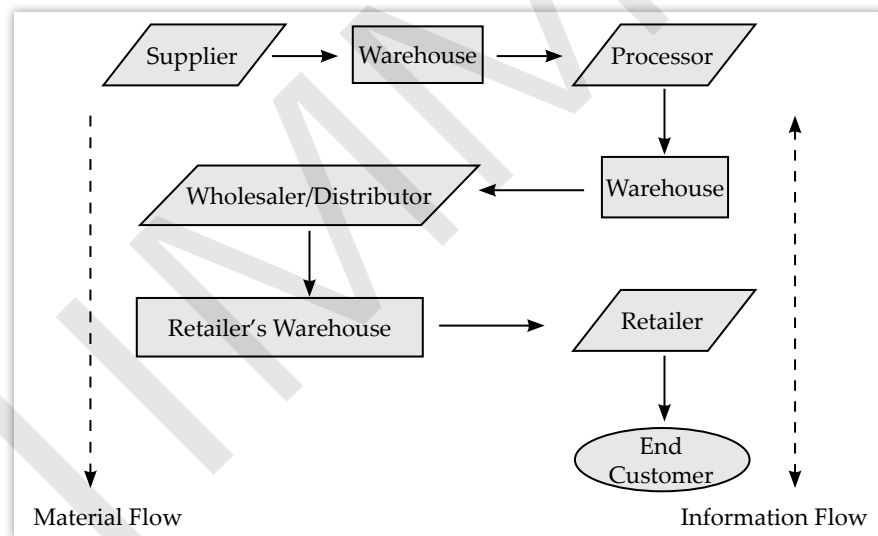

FIGURE 1: Graphical Representation of a Supply Chain Flow

### 2.2.1 | DEFINITION OF SUPPLY CHAIN MANAGEMENT

The **Council of Logistics Management (CLM)** (now the Council of Supply Chain Management Professionals) revised the definition of logistics in 1998 as *that part of the supply chain process that plans, implements, and controls the efficient, effective flow and storage of goods, services, and related information from the point of origin to the point of consumption in order to meet customers' requirements.*

According to the **Institute for Supply Management**, *supply chain management refers to the design and management of seamless, value-added processes across organisational boundaries to meet the real needs of the end customer.*

According to **Stock and Lambert**, *supply chain integrates the key business processes of an organisation from end user through original suppliers that provides products, services and information that add value for customers and other stakeholders.*

According to Profs' Mohanty and Deshmukh, A supply chain is a network of facilities and distribution options that performs the functions of procurement of materials, transformation of these materials into intermediate and finished products and the distribution of these finished products to customers.

According to Thomas and Griffin, SCM is the management of material and information flows both in and between facilities such as vendors, manufacturing and assembly plants, and distribution centres. It includes various activities, such as inbound and outbound transportation, warehousing or inventory control.

According to American **Production and Inventory Control Society (APICS)**, SCM refers to the *design, planning, execution, control, and monitoring of supply chain activities with the objective of creating net value, building a competitive infrastructure, leveraging worldwide logistics, synchronizing supply with demand and measuring performance globally*. Thus, SCM involves movement and storage of raw materials, work-in-progress inventory and finished goods.

SCM collaborates the organisations processes from seeking goods from suppliers, to be transformed into finished products so that demand for customers can be met. SCM is an approach used to efficiently manage the entire life cycle of a product starting from supplier, undergoing manufacturing, inventory management and provide products at the point of consumption. SCM also entails manufacturing and distributing finished products in the right quantity, at the right locations and at the right time. It further aims at mitigating operational costs while satisfying customer expectations.

SCM can be deduced as a network of all organisation processes and activities entailing procurement of raw materials, manufacturing them and distribution of finished products. SCM is a cardinal process as a viable supply chain results in reducing costs and a speed-up of the production cycle.

The advent of globalisation has enabled organisations to expand beyond international borders and re-structure the way customers' demands and products' supplies are managed. Supply chain management is utilised by organisations pan globe, so they can optimise on costs and stay buoyed in the present competitive scenario.

### 2.2.2 | OBJECTIVES OF SUPPLY CHAIN MANAGEMENT

The SCM covers various functions that initiate with receiving orders from customers to fulfilling the orders. The various functions may also include modifying product, marketing the product, managing operations, distribution channels, finance and providing after-sales customer service. A robust supply chain management can cut down on an organisations overall costs and bolster profitability. SCM also aims at mitigating delays in finished products' delivery to the target market and enhance customer service.

The SCM approach is adopted in organisations to build cordial relationships among all the involved parties in the supply chain network. The main objective of any SCM is to ensure a smooth flow of products to maximise customer satisfaction.

Some of the important objectives of SCM are enlisted in Figure 2:

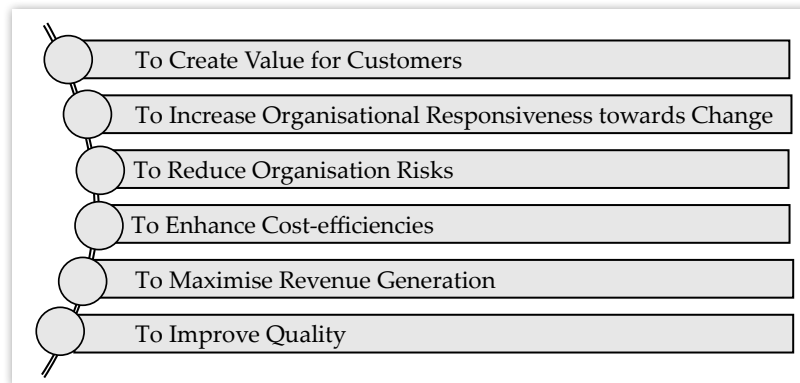

FIGURE 2: Objectives of SCM

Let us discuss these objectives in detail.

- **To create value for customers:** Customer satisfaction is the primary goal of any organisation for its overall success. SCM aims to add customer value by establishing a market-driven customer service strategy based on customer requirements. This results in repetitive business for the organisation.
- **To increase organisational responsiveness towards change:** Organisations need to adapt to many changes on a frequent basis with respect to the changes in the business environment, such as the advent of new technologies and changes in government policies. Effective SCM helps the organisation quickly respond to such changes.
- **To reduce organisation risks:** Many a time, organisations encounter various disruptions in the entire organisation network, such as natural disasters, cataclysmic weather, labour strikes, and supplier failures. These sudden disruptions affect the smooth flow of products and services in the market, which may lead to major consequences for organisations. A sound SCM network enables organisations to reduce such risks by establishing backup plans.
- **To enhance cost-efficiencies:** The major objectives of SCM are to reduce inventory-carrying costs, minimise labour expenses, cut expenditures on freight spend, etc., for achieving cost-efficiencies. For this, organisations adopt various measures in SCM, such as using contracts or a bid/proposal to obtain economic resources at the lowest cost possible.
- **To maximise revenue generation:** SCM is important for organisations as it aims at maximising on the profits of the organisation. SCM reduces the operational, inventory and transportation costs, which, in turn, will increase the profitability. A key component of SCM is transportation, which refers to the movement of finished goods from a warehouse to the ultimate market destination. If the finished goods do not reach the market on time, the customers' demand will not be fulfilled and will result in loss for the organisation. Thus, SCM aims at maximising the revenue for the organisation.
- **To improve quality:** SCM forms an important link between the supplier and the organisation. The supplier is the one who is well-versed with the current customer

demand and market trends. The supplier can provide useful inputs or feedback on the products being provided by the organisation and where the product is lacking in quality or meeting the expectation of customers. Thus, one by one, the organisation can make necessary amends in the product to improve the quality of the finished product. The organisation would want to make a product that is preferred by the customer and meet its satisfaction level. Higher satisfaction level will even help the organisation retain customers for a longer period of time and increase its goodwill. A satisfied customer will create a generic word-of-mouth advertisement for the organisation and can enable the organisation to enlarge its customer base.

### 2.2.3 | IMPORTANCE OF SUPPLY CHAIN MANAGEMENT

Supply chain management is an extensive process used by organisations to make the products reach the consumers. SCM starts from obtaining raw materials from suppliers, transforming them into finished goods and providing the final product to the target customer. A well-galvanised supply chain management ensures swift delivery of finished products within a stipulated time span.

SCM in the modern context entails the strategically aligning of end-to-end business processes to meet market and economic value. Moreover, it gives the organisation an edge over its rivals. The origin of the new digital age has given a new dimension to the field of commerce. Two decades ago, supply chain processes were uphill, laborious, time-consuming and mismanaged. Some years back, product shipment used to take a week or a month's time which has been cut short to a few days and, at times, in a matter of hours owing to the introduction of SCM. The world can be considered as an extensive supply chain. Customers and organisations are perennially interacting with each other. The raw materials undergo transformation and various processes before reaching the ultimate destination. Efficient SCM fulfils the need of both organisations and consumers while operating at multiple levels.

It is important for organisations to maintain flows that are:

- **Physical flows:** They comprise transforming, moving and storing of raw materials. They are tangible in the supply chain and are of utmost importance for the organisation.
- **Information flows:** They enable various individuals involved in the supply chain to collaborate long-term plans and control the day-to-day flow of goods and materials throughout the supply chain.

By attaining efficacy in operation and customer satisfaction, SCM has a major role to play in the success of an organisation. Moreover, SCM provides a competitive edge to the organisation by ensuring a smooth flow of products and services in the market. The following points explain the importance of SCM:

- It helps an organisation in bringing down inventory costs by proper inventory management.
- It enables dissemination of information effectively between various partners in a network.
- It also helps an organisation in enhancing customer satisfaction by making on-time delivery.

## NOTES

- It helps in building trust between various partners as they work together.
- It also improves profits of the organisation by increasing the efficiency of operations.
- It enables an organisation to cut down on cost of procuring and manufacturing.
- It also offers various tools and techniques to identify disruptions and solve them on time.

## SELF ASSESSMENT QUESTIONS

1. The advent of \_\_\_\_\_ has enabled organisations to expand beyond international borders.
2. Supply chain management forms an important link between the supplier and the organisation. (True/False)

### 2.3 ROLE OF LOGISTICS IN SUPPLY CHAIN MANAGEMENT

Logistics is a key component of SCM. Logistics involves planning, managing goods/services and sharing information from the point of origin to the desired point of consumption by the customer. Logistics integrates the perplex pattern of transportation, shipping and receiving, import and export of goods, warehousing, inventory management, procurement, planning for the production process, serving customers, etc.

Logistics forms a pivotal blueprint of SCM in an organisation. Logistics is used for managing, coordinating and monitoring resources required for smooth movement of products in a timely, cost-saving and reliable manner. Logistics in supply chain management strikes a balance between supply and demand. Successful implementation of logistics in supply chain management by an organisation ensures higher revenues and improved performance level. Logistics is an indispensable part of supply chain management which requires due investment and planning. Amazon, Costco and Walmart are some renowned organisations that have reaped the benefits of successful management of logistics in supply chain management.

The role of logistics in supply chain management is explained as follows:

- **Order processing:** It is of prime importance in logistics operations. The purchase order issued by an organisation to a supplier serves as a crucial legal document between both of them. A purchase order comprises the attributes or technical details of the product, price, delivery period, payment terms, taxes and other terms pre-agreed by both organisation and supplier. The order processing is pivotal as it bears direct impact on the order cycle time, which explicitly mentions the time when the order was received and when the product was received by the customer. The order processing consists of the following steps:
  - To cross-check if the order is in line with negotiated pre-agreed terms.
  - To verify prices, payment and delivery terms.
  - To check the availability of materials in stock.
  - To produce and schedule material.
  - To acknowledge the order and specifying deviations, if any.

- **Inventory control:** Inventory refers to the stock of materials in retail organisations. Inventory management refers to having sufficient inventories to fulfil the customers' requirements and simultaneously reducing the storage cost. Inventory control basically aims at balancing the customer satisfaction level and reducing the cost at the same time. Improper inventory can hamper the organisation's profits due to the huge costs associated with the inventory. While the products are in inventory, they must be prevented from losses, damages, thefts and pilferage.
- **Warehousing:** Warehousing refers to storing of finished goods until they are sold or shipped to the ultimate destination. Warehousing plays a crucial role in the logistics of an organisation. In the context of supply chain management, a warehouse is a requisite as the products once manufactured need to be stored. They cannot be left in the open as it may harm the product. Warehousing prevents the products from getting affected by the environment. Some of the important aspects while selecting a warehouse are its location, storage type and material - handling equipment.
- **Transportation:** Transport is the single most important aspect of logistics activities in manufacturing organisations. The physical movement of finished products is pivotal as unless products do not reach the target customers, the demand or customer satisfaction cannot be fulfilled. Transportation ensures delivery of products from the point of origin to the point of consumption. Timely availability of products is of prime importance as only then the reason to manufacture a product will be attained.
- **Packaging:** Packaging is a logistic activity that is crucial in SCM. It is a must for every manufacturing organisation. Packing ensures that during the physical distribution of a product, they do not get affected or lose their quality. Correct packaging assists in minimising damage to finished products and saving the products from spoilage, pilferage and thefts. Packaging also provides a customer with the specification of the product, such as its weight, date of a manufacturing, name of manufacturing organisation, ideal time for product consumption, and price.
- **Information:** Logistics is fundamentally an information-driven activity that deals with the movement of inventory throughout the supply chain. Information system works like oil of the machinery that aims at delivering quality service to the customers. The use of information technology has further enabled logistics in information identification, storage, scrutiny, archiving, retrieval and decision-making which are the key functions of logistics. Such logistical functions enable an organisation to hone its competitiveness.
- **Material handling:** The pace of the movement of inventory throughout the supply chain is hinged on the methods employed for material handling. A disorganised material-handling method may cause damage to the product, untimely product delivery and increase the overhead cost. By implementing automation in the material handling process, an organisation can enhance the productivity, product delivery and mitigate the chance of damage to the product. While choosing the material-handling system, an organisation should also consider the volume of products to be handled, the necessary speed required for the movement of materials and the service level to be offered to the customer. The warehouse size is also important for effective space utilisation (floor and cubic) of storing products.

NOTES

The material handling system should be effective enough to support the storage system for swift flow (storage and retrieval) of goods in and out of the warehouse.

SELF ASSESSMENT QUESTIONS

3. An organised material-handling method may cause damage to the product, delay product delivery and increase the overhead cost. (True/False)
4. \_\_\_\_\_ ensures that during the physical distribution of a product, they do not get damaged or lose their quality.

**2.4 DIFFERENCE BETWEEN LOGISTICS AND SUPPLY CHAIN MANAGEMENT**

According to Senior Partner, KOM International, **Peter Reed**, *Supply chain comprises all aspects of a product cycle from origin to end user, for example, from farm to fork. Logistics relates to one component of the supply chain, addressing efficient product movement, such as from manufacturer to retail store.*

Logistics is a term coined to define and elaborate the entire process of managing goods within a specified department, simultaneously maintaining inventory document of the status and whereabouts of various inventories. In other words, logistics can be termed as the process to plan, execute and control the flow of goods and various activities. Logistics collaborates various activities, such as movement of goods, services, information and funds. Logistics initiates from the sourcing of raw material from the supplier till the finished products reach customers. The logistics activities can be divided into:

- **Inbound logistics:** It encompasses activities related to the procurement of raw material, handling goods, storage facility and transportation of finished products.
- **Outbound logistics:** It covers activities pertaining to storage and distribution or delivery to the final consumer. It initiates with receiving customer sales order, picking up the product from the warehouse, and culminates with the delivery of the product.

Supply chain management is a term that refers to the entire set of activities, that covers the procurement of raw materials, receiving of raw materials, manufacturing goods and delivery of the finished products to target customers or destinations. Supply chain management refers to a series of interlinked activities pertaining to the converting of raw material into finished products. SCM is the result of inputs from multiple organisations that assisted in successfully completing a chain of activities. SCM includes activities, such as linking of activities, sourcing from supplier, procurement, production, testing, measuring customer satisfaction and performance level.

Basis	Logistics management	Supply chain management
Meaning	It interlinks the flow of goods, storage, sharing of services and information inside and outside the organisation	It deals with coordinating and managing supply chain activities (product planning, sourcing, executing, delivering and return, if any)

Basis	Logistics management	Supply chain management
Aim	It aims at reaching the desired customer satisfaction level	It aims at gaining a competitive edge over competitors
Evolution and development	It is traditional. Though it has evolved earlier, it has its origin from military	It is relatively a modern concept
Organisations involved	Single	Multiple
Technology used	Logistics uses Total Management System and Warehouse Management System	Supply chain management uses technologies, such as Enterprise Resource Planning, Customer Relationship Management Software, Big Data and Radio Frequency Identification
Relationship with other departments	It has a minimal relationship with other departments	It extensively interacts with other departments
One in another	Logistics is a fraction within SCM	SCM can be deduced as a new version of logistics management

NOTES

#### SELF ASSESSMENT QUESTIONS

5. Logistics has its origin from \_\_\_\_\_ field.
6. Supply chain management aims at gaining a competitive edge over competitors. (True/False)

## 2.5 SUMMARY

- Supply chain management connects suppliers to customers by providing products, services and information and offering value-added services.
- Supply chain is a network of transportation and warehousing processes that ensures procurement, distribution, and movement of materials from the point of origin to the point of consumption.
- The objective of a supply chain is to ensure that the right product reaches the right customer, in the right condition, at the right time and at the right price.
- In the late 1990s, the term gained prominence as a management buzzword and organisational managers began to use it more often.
- Every organisation aims to satisfy its customers in the best possible manner. In order to serve customers better, an organisation needs to make timely and undisruptive availability of products and services.
- Logistics is that part of a supply chain process that plans, implements and controls the efficient, effective storage and flow of goods, services and related information from the point of origin to the point of consumption to meet customer requirements.
- The supply chain management approach is adopted by organisations to build cordial relationships among all the involved parties in the supply chain network.
- The supplier can provide useful inputs or feedback on the products being provided by the organisation and where the product is lacking in quality or meeting the expectations of the customers.

## NOTES

- Logistics integrates the perplex pattern of transportation, shipping and receiving, import and export of goods, warehousing, inventory management, procurement, planning for the production process, serving customers, etc.
- Logistics is an indispensable part of supply chain management which requires due investment and planning.
- The purchase order issued by an organisation to a supplier serves as a crucial legal document between both of them.
- Logistics collaborates various activities, such as movement of goods, services, information and funds.
- Logistics initiates from the sourcing of raw material from supplier till the finished products reach customers.

## 2.6 KEY WORDS

- **Supply Chain Management (SCM):** It is the management of all activities that are performed at different stages of production for effective product delivery in the market.
- **Logistics:** It integrates the perplex pattern of transportation, shipping and receiving, import and export of goods, warehousing, inventory management, procurement, planning for the production process, serving customers, etc.
- **Inventory control:** It basically aims at balancing the customer satisfaction level and reducing the cost at the same time.
- **Physical flows:** They comprise transforming, moving and storing of raw materials. They are tangible in the supply chain and are of utmost importance for an organisation.
- **Information flows:** They enable various individuals involved in the supply chain to collaborate long-term plans and control the day-to-day flow of goods and materials throughout the supply chain.

## 2.7 CASE STUDY: SUPPLY CHAIN AT WHIRLPOOL

Whirlpool is one of the pioneering American multinational organisation having 70 manufacturing units and various reach centres throughout the globe. Whirlpool manufactures electronic appliances for household use. It is listed in the Fortune top 500 companies with an annual revenue of approximately \$19 billion. However, in 2000, the performance level of Whirlpool tumbled against its regular standards. The current supply chain network proved to be incapable to meet the satisfactory level.

There were many aberrations in the inventory level, material handling and finished product quality that Whirlpool offers was degrading. The top management of Whirlpool realised that it was high time to bring about a change in the *status quo*. The management of Whirlpool analysed and identified that the wide geographical location of Whirlpool was unable to fulfil its supply chain operations. Whirlpool supply chain management and IT department initiated the task of solving supply

chain problem and streamline distribution system to enhance finished product quality.

Whirlpool introduced logistics management in its system. The problems that were troubling Whirlpool such, as material handling, packaging issue and transport, were dealt with by logistics. Efficient material handling and packaging ensured that the products do not lose their quality in transit, whereas the transport function ensured that products reach their destination in time and at the desired location.

After a span of four months, Whirlpool realised that the supply issues came down considerably and the inventory system improved. Subsequently, the material handling was streamlined and there were no anomalies in the system. The customer demand was also being fulfilled on time.

## QUESTIONS

1. What were the key issues in Whirlpool?

(**Hint:** The performance level was degrading and the supply chain network could not meet the satisfactory level.)

2. What were the supply chain problems in Whirlpool?

(**Hint:** The organisation was not able to serve its vast geographical area.)

3. Which problems were dealt with by logistics in Whirlpool?

(**Hint:** The logistics addressed problems, such as material handling, packaging issue and transport.)

4. What did material handling and packaging ensure?

(**Hint:** It ensured smooth flow of material and that the finished products do not get hampered while in transportation.)

## 2.8 EXERCISE

1. Discuss the main objectives of supply chain management.
2. What is the importance of supply chain management for an organisation?
3. What are the three decision phases of supply chain management?
4. Differentiate between logistics management and supply chain management.
5. Describe the role of logistics in supply chain management.

## 2.9 ANSWERS FOR SELF ASSESSMENT QUESTIONS

Topic	Q. No.	Answer
Concept of Supply Chain Management	1.	globalisation
	2.	True
Role of Logistics in Supply Chain Management	3.	False
	4.	Packing

## NOTES

Topic	Q. No.	Answer
Difference between Logistics and Supply Chain Management	5.	military
	6	True

## 2.10 SUGGESTED BOOKS AND E-REFERENCES

### SUGGESTED BOOKS

- Chopra, S., & Meindl, P. (2014). *Supply Chain Management* (1st ed.). Hallbergmoos: Pearson.
- Fredendall, L., & Hill, E. (2001). *Basics of Supply Chain Management*. Alexandria, Va: APICS.

### E-REFERENCES

- S,S. (2019). Difference Between Logistics and Supply Chain Management (with comparison chart) - Key Differences. Retrieved 18 September 2019, from <https://keydifferences.com/difference-between-logistics-and-supply-chain-management.html>
- The Basic Concepts of Supply Chain Management. (2019). Retrieved 18 September 2019, from <http://www.ecrasia.com/the-basic-concepts-of-supply-chain-management/>

# Transportation: Backbone of Logistics

## Table of Contents

---

- 3.1 Introduction
- 3.2 Concept of Transportation
  - Self Assessment Questions
- 3.3 Modes of Transportation
  - 3.3.1 Road Transport
  - 3.3.2 Pipeline Transport
  - 3.3.3 Rail Transport
  - 3.3.4 Air Transport
  - 3.3.5 Sea Transport
  - 3.3.6 Multi-Model Transport
    - Self Assessment Questions
- 3.4 Factors Influencing Transportation
  - Self Assessment Questions
- 3.5 Documents Used in Transportation
  - Self Assessment Questions
- 3.6 Summary
- 3.7 Key Words
- 3.8 Case Study
- 3.9 Exercise
- 3.10 Answers for Self Assessment
- 3.11 Suggested Books and e-References

**LEARNING OBJECTIVES**

*After studying this chapter, you will be able to:*

- Explain the meaning of transportation and its concepts
- Outline various modes of transportation
- Explain the factors which influence and affect transportation
- Describe the important documents which are used in transportation

**3.1 INTRODUCTION**

In the previous chapter, you studied the concept of Supply Chain Management (SCM). The chapter also described objectives of SCM and importance. Further, the chapters also explained the role of logistics in SCM. At last, the chapter enlisted the differences between logistics and supply chain management.

Under logistics operations, transportation means delivering products to customers on time, in the right quantity, in the good condition and at the right price. It is the transportation system of a country that forms the base and plays an important role in the progress of a country's economic, social and commercial growth. It has brought together all the different countries of the world and has created an organisation in itself.

The overall cost of a product also includes the cost of transportation and there is a great level of planning which is required to control transportation cost. It is the most significant part of a supply chain and has scope with immense opportunities.

The role of transport is moving goods and people from one place to another. It is one of the most important factors for promoting a country's growth in trade and commerce. Not only does it promote growth, but it also helps the country in achieving its social and economic goals. With the changing business dynamics, there is a change in the modes of transportation as well, depending upon the change in the needs and requirements of the people. There are various technologies which are being used in order to improve the transportation of a country. It is moving in tandem with the changes in science and technologies.

There are various equipment used in the transportation of goods from one place to another. The equipment is both simple as well as sophisticated. Use of sophisticated equipment depends upon the level of the country's economic condition as well as the level of growth.

The farming techniques and manufacturing activities have also changed and so have the modes of transportation. This development was required in order to efficiently and safely move goods. In the ancient world, goods were transferred from one place to another with the help of animals such as horses, donkeys, bullock carts, etc. These techniques consumed a lot of time for goods to reach the destined place. Also, the capacities of these modes were not much. The histories of Greek, Persian, Mohenjo-Daro empires have witnessed these modes of transportation. With the beginning of the Industrial Revolution, transportation experienced huge changes. There was a need to make travel and movement of goods and people easier. This led to the development of four major modes of transportation: road, rail, water and air.

Before Independence, there were only two modes of transportation which were used in our country. They were roads and railways. Ports and cities were built as strategic imperatives for the government. Post-Independence, the development in railways and road transportation became the main focus of the government in order to develop the economy of India. Gradually, sea and air transport also developed.

Transportation in logistics system comprises of two major activities: movement of goods from one place to another and in-transit storage of those goods. The mode of transportation which is used also depends upon the availability of the infrastructure of that particular region. The principle which guides in choosing a mode of transport is the cost per unit weight/volume of a product. The per-unit cost of a product used over a unit distance should be the least.

In this chapter, you will study the concept of transportation as it is a cardinal aspect of product delivery. The chapter will also give insight into various modes of transportation such as road, pipeline, rail, air, sea and multi-model transport. Further, the chapter will also discuss the various factors affecting transportation and the documents used in transportation.

## 3.2 CONCEPT OF TRANSPORTATION

The movement of people, goods and animals from one place to another is the basic concept of transport or transportation. It helps in enabling trade between people and organisations in order to develop a nation. The various components of transportation are:

- **Infrastructure:** There are various fixed infrastructures which enhance the different modes of transportation. These infrastructures include roads and terminal facilities, bus stands, railways and railway stations, airways and airports, waterways and seaports, pipelines and canals, warehouses, land used for parking and maintenance, etc.

There is a need of fixed installation of infrastructures in order to move goods via roads, railways and pipelines. However, this installation can be avoided when using sea and air as modes of transport. There is a need for construction of ports in these cases.

In order to build and maintain such installations and infrastructures, there is a need for financing. Transportation services can get financial help from either public sectors or private sectors. We all know that transportation is the basic need of the people and in most of the countries, the construction of infrastructure is funded with the taxes paid by the citizens of the country. In cases of advanced infrastructure, there is a need for huge investment. To cover the cost of investment there are fees imposed by infrastructure owners for usage, landing and tolls on roads.

- **Vehicles:** There is a need for vehicles in order to move goods and people. Infrastructures are fixed, but vehicles are tangible and moving devices which carries both people and commodities from one place to another. In most of the cases, vehicles are required to be driven by individuals. However, in the modern context, we have self-driven vehicles which are fully automated and are able to move goods from one location to another.

## NOTES

- **Operation:** Transportation is operated by both public and private individuals. In case of private transport, there are owners of vehicles, who are solely responsible for the movement of goods from one place to another, and who carry out all the related activities which forms a part of transportation. In case of public transport, government is involved in the operations of transportation. Since privatisation yields better service, most of the transportation operations are taken up by the private sectors. This is leading to a high rate of competition among industries.
- **Policy:** In order to maintain order and discipline in the transportation system, there are several policies that have been instituted by the government. This has been done keeping in view the rapidly increasing rate of population in countries.

## SELF ASSESSMENT QUESTIONS

1. The role of transport is moving goods and people from one place to another. (True/False)
2. Fixed \_\_\_\_\_ enhances the different modes of transportation.

### 3.3 MODES OF TRANSPORTATION

As already mentioned, there are different modes of transportation prevalent in the countries. The movement of goods from one place to another has become substantially easy with so many options available. Be it the movement of goods within a country or outside, almost everything can be transported.

Different modes demand different forms of infrastructure and technology. For transportation by road, there is a need for well-constructed and well-built roads, highways, bridges, etc., which forms a link between two different locations. Bridges should be built in such a way that they are able to bear the weight of moving trucks which are carrying goods in them. For transport by railways, very good connectivity between places is required in regard to distance. The distance should not be much and the time taken for goods to be delivered should be the least. For transport by sea, a large number of ports should be located near the major cities for goods to reach the right place at the right time. For transport by air, advanced aeroplanes that can carry a large amount and volume of goods must be used.

#### 3.3.1 ROAD TRANSPORT

The most preferred mode of transport which has been of great help to the industrial and agricultural sectors of a country is road transport. It is the most suitable mode for moving goods from one place to another, where the distance is very short and where other modes are unable to reach or are just not available. The most important benefit of this kind of transport is that it delivers goods at the doorstep of the customers which other means of transport lack.

With the use of road transport, rural life gets easily connected with urban life and vice versa. It provides such infrastructure which allows agricultural goods and products from rural areas to reach people of the urban areas. In the same way, industrial products from urban areas reach people of rural areas. This connectivity ensures balance in the lifestyles of the people in different areas.

There has been substantial growth in the industrial as well as in the agricultural products because transport by road has provided facilities which helps the manufactured products to reach the right people at the right time. The products are easily available in places of its actual consumption with the help of transport by road.

Amongst all other means of transport, road transport has gained much importance and value because of the following advantages which it provides:

- Door-to-door service
- Flexibility
- Reliability
- Reaching remote places and
- Speed

### 3.3.2 | PIPELINE TRANSPORT

Samuel Van Syckel, in the year 1870, was the first person to develop pipeline transport. Pipeline transport was first used to transport petroleum from one place to another. With time and other developments in place, 20 years later, the Standard Oil Company brought about a huge and evident change in the pipeline mode of transport. Apart from petroleum, which was the first thing to be transported via pipeline, other things such as fines of iron ores, different natural gases, coal in slurry form and other such chemicals became parts of products which were transported through pipelines.

Pipeline mode demands huge investment, but still, the operational cost of moving products from one place to another is reduced. In India, most of the public and private petroleum refineries use pipeline mode to transport oil from one place to another. One of the best examples of transport of iron ore fines in its slurry form is the Kudremukh Iron Ore Project which uses pipeline mode of transport to deliver iron ore fines over a distance of around 67 kilometres by the Western Ghats.

As compared to other modes of transport, pipelines are the best eco-friendly mode and also, the cost of this mode of transport has seen a downward trend whereas other modes have seen an increase in their cost with time. For moving a tonne of oil over a distance of 1 kilometre, the cost incurred by a new pipeline is INR 1.15. If in place of a new pipeline, a depreciated pipeline is used, the cost incurred comes down to INR 0.87.

Now, if we compare this cost with that of road transport carrying moving oil, we see that the cost is INR 2.50 per tonne per kilometre and that by railways is INR 2.00. So, we can clearly say that pipelines are less costly.

No matter how much the initial investment is huge, but, in regard to the reduced operational cost, the overall investment is minimised.

### 3.3.3 | RAIL TRANSPORT

The primary mode of transport which facilitates the movement of people and goods from one place to another are railways. It forms an important part in boosting the trade and commerce of a country and has helped a lot in the industrialisation of nations. When it comes to transporting the most important commodities from one place to another, railways is the first option because it is widely connected with different states of the country in regard to its length and breadth. In the beginning of industrialisation, countries were highly dependent on railways because it was the basic mode of moving raw materials as well as finished goods from one place to another.

If we talk about dependability on modes of transport, we can always rely on railways as it is the most reliable and the safest mode of transport. Trains help in carrying goods and people from one place to another in a short period of time. Also, they are least affected during weather changes. Though it does get affected, but the damage to products is still less as compared to other modes.

Railways are an organised mode of transport. Trains have specific and pre-decided routes and halts. Also, the time for goods to reach their destination is also fixed. So, the customers know when they will be expecting their goods.

Railways forms an integral part of the economic progress of a country because it mobilises people as well as goods. However, railways also have certain constraints. The biggest drawback is the cost. Railways demand heavy investment and the cost incurred in transportation is also very high. Establishing a network of railways as a transport system is not enough. The maintenance is also important which involves higher costs. Moreover, since railways cannot provide door-to-door service, the additional cost is incurred in loading and unloading of the products in order to deliver goods at doorsteps by means of road transport. Continuous loading and unloading causes wear and tear of goods in many cases.

### 3.3.4 | AIR TRANSPORT

Transportation by air is the biggest and the most expensive mode of transport and hence, it is only used to move goods which are highly perishable and values of which are very high. The movement of goods from one place to another via air is not affected by any barrier. It is an unbreakable journey over both land and sea, barring the mountains and forests. This mode is the fastest of all other modes.

Air transport enables a country to achieve its economic development and growth. It brings together economies of different countries and helps in the integration of international trade and commerce.

There are advanced and special preparations required in order to transport goods via air. Aircraft with advanced technologies are used for carrying expensive goods. Moreover, there is no extra investment needed to construct tracks such as, on roads, railways and water.

The biggest advantage of using air as a mode of transport is that it can be used in places where it is difficult to reach. During natural calamities like floods and earthquakes, airways are the only mode which remains unaffected and can be used in emergencies. This is the reason why it is used at times of natural calamities to provide victims with food, medicines and also by moving people to unaffected areas of land.

The clearance time for goods moving via air is very less. Also, the custom formalities are done too quickly as compared to other modes.

The biggest support which air transport provides to a country is at the time of defence. It is used during wars to destroy enemies.

Air transport has also helped countries in exploring space. It helps in carrying satellites and people and provide valuable space information.

### 3.3.5 | SEA TRANSPORT

Transport by sea involves transporting goods and people through water mode, such as ships, boats, barges and sailboats over water bodies from one place to another. There are ports built near seas and oceans in different cities where goods from different places are loaded and unloaded at different ports of different cities.

Sea transport is best suited for transporting goods which are non-perishable. Goods are also referred to as cargo. This mode of transport is less costly as compared to air and is also the largest carrier of freight in the whole world. This mode of transport is used by people who are involved in receiving goods from distant suppliers. There are containers of different sizes which are used to carry goods via sea which also involves movement of loose products such as grains. There are different sizes of containers which are used to transport different types of products in order to keep it safe from weather conditions.

There are different services provided by sea transport. They are:

- To move goods to and from the seaports
- To transport FCL (Full Container Load) which includes containers of 20 to 40 feet sizes, refrigerators, etc.
- To transport LCL (Less than Container Load) which involves transportation of goods of different clients in a single container
- To archive important and relevant documentation
- To provide customs and brokerage services
- To provide cargo delivery which also includes door-to-door services

### 3.3.6 | MULTI-MODEL TRANSPORT

As the name itself suggests, a multi-model transport involves transport using more than one means. A combination of different modes of transport is known as multi-model transport. This mode of transport is basically used to facilitate the movement of goods and people from one place to another in the most efficient and fastest way.

## NOTES

Organisations use this mode of transport because delivering goods from one place to another is not possible by using a single mode. Therefore, organisations use a combination of different modes which facilitates each other and delivers the goods to the destined places. Trucks, ships, trains and aeroplanes, all of these are used in order to transport goods.

This mode is beneficial only when an effective combination of modes is used. While making a combination, modes should be taken together in a way which optimises the overall cost and delivers the goods on a timely basis meeting the deadlines.

Despite the effective combination, this mode of transport may incur huge costs in relation to charges such as freight and handling. However, some organisations hire their own freight forwarding companies which helps them in reducing such costs by providing an interface between different modes of transport.

There are various advantages of this transport. They are:

- All the responsibilities of transport are centralised in a single transport operator.
- International experiences are used both in transportation and in commerce.
- Economies of scale in negotiations of transport by way of using better infrastructures and modes of transport which reduces the overall cost of transportation and reduces indirect costs.

## SELF ASSESSMENT QUESTIONS

3. FCL (Full Container Load) transportation, which includes containers of 20 to 40 feet sizes, refrigerators, etc., is a part of air transport. (True/False)
4. Door-to-door service is an advantage provided by \_\_\_\_\_ transport.

### 3.4 FACTORS INFLUENCING TRANSPORTATION

Unless and until there are adequate facilities available, movement of goods by means of roads, rails, sea or air will not be successful. The goods are required to move from one place to another in the most efficient way. There are various factors which influence and affect transportation in logistics. The construction, production and dispatches are affected by the following factors:

- **Terminal facilities:** Terminal facilities means all of the required land, infrastructure and equipment which are very important for operations in a warehouse. They are all used for the accommodation of products as storage places as well as for transport facilities of those products. These facilities are not provided to an organisation easily. One of the reasons for this is that any sort of inconvenience caused to the truck drivers and operators affects the carrier and not the goods and the project. It is a loss for the carriers.

The storage space of the produced goods must be adequate because if there is no space available to store any further produced goods, the production gets hampered. For each kind of goods, there is a different transport facility available in relation to the requirement of those products. There are different requirements of

transport facilities depending upon the availability, location and type of product. There must be different terminal facilities for different kinds of products.

While planning for terminal facilities, things such as loading and unloading lines, storage space, availability of well-constructed roads, and railways, should also be considered. Not only planning, but the maintenance of these facilities must also be kept in mind because it is very essential for transportation.

The overall cost of transport includes the expenditures incurred in various other terminal facilities. For the movement of products by rail, loading lines must be planned for in advance. The way lines are configured is more important than its length because an easy movement of goods through connected lines is essential.

- **Vehicles:** One of the most important things to be kept in mind is the use of a specific type of vehicle for the transport of goods. There are different kinds of goods and commodities which are transferred from one place to other which differ in size, volume, nature, etc. Considering all these things in mind, different vehicles need to be used depending upon specific product types. In case of transport of goods by sea, the capacity of the ship to carry the loads, the speed at which it will move needs to be examined. Similarly, in cases of delivery of goods by roads, rails and air, the size of the vehicles and the type of goods which can be transported will be examined.
- **Fuel cost:** Fuel cost plays a very vital role in the transport industry. As and when the price of fuel comes down, the transport price also goes down and vice versa. This indirectly benefits customers as well.
- **Government regulations:** There is a direct impact of government regulations in the transport industry. Government may levy specific hours of driving for commercial operators. They may set certain rules and regulations which directly affect the charges of freight while carrying goods from one place to another.
- **Transit time:** The distance between the storage place or the warehouse to that of the customers or the suppliers determines the time in which goods can reach to the ones who most need it. In general practice, this transit time is not given any attention and this, at times, leads to higher overall transportation costs. If there is a need for cutting down the transit time, organisations switch to air transport. However, the lower transit time, in real practices, does not validate the use of air as a mode of transport.

Some of the most important projects suffer a loss if raw materials and equipment do not reach on time because it leads to delay in their production activities. Choosing a mode of transport which is able to deliver goods on time is very important.

The schedules for construction are pre-decided. Along with this, the order numbers and the processing time for those orders are also pre-decided. The only thing which is often ignored is the transit time of the goods. Lack of proper planning on delivering goods on time leads to huge losses for businesses.

- **Routes and sectional capacities:** There are various routes through which goods move in order to reach their customers. The availability of these routes and their capacity to carry the same amount of merchandise from the starting point to the point of consumption is very important. It happens in all organisations where

## NOTES

the decision-makers assume that there is enough number of routes and sectional capacities available for the goods.

Also, there are different speeds and volumes of carrying goods and rules assigned to different routes of roads, air and water. These minor but important aspects are ignored by organisations, which affects the time of delivery of merchandise. This is known as the sectional capacities of different routes.

There are a number of routes available for the movement of goods and, to these routes, there are a maximum number of moving vehicles assigned at a given point of time, keeping in mind the availability of terminal facilities.

- **Distribution pattern:** The pattern of distribution of different types of goods is another important factor that influences transportation. Movement of goods takes place at different stages of its production; from raw materials supplied to the organisation by the suppliers to delivery of finished products to the actual customers. Some goods directly reach the customers from the warehouse, while some are distributed to the wholesalers, retailers and then to the final consumers. These different patterns of distribution demand proper transportation facilities and planning.

Moreover, there are goods which are meant to be sold within the country itself and then there are goods which need to be exported to different countries. The overall national and international trade of a nation involves different distribution patterns.

Detailed information regarding the type of goods to be transported, the place where it needs to be transported, and other important information should be provided to the carrier services so that they can adequately plan the movement of goods in its entire range.

- **Nature of product:** The most valuable aspect of the movement of goods is the nature of products that are being moved from one place to another. This aspect demands very sophisticated planning so as to deliver goods as undamaged to the customers. The type of containers to be used, the way product needs to be packed, the time in which the product should reach the consumers, all should be kept in mind. Some goods are perishable and some are non-perishable and they should be transported accordingly. Some goods require special handling and should be packed accordingly. These are some of the most important factors affecting transportation.

## SELF ASSESSMENT QUESTIONS

5. As and when the price of fuel comes down, the transport price also goes down and vice versa. (True/False)
6. \_\_\_\_\_ means all of the required land, infrastructure and equipment which are very important for operations in a warehouse.

**3.5 DOCUMENTS USED IN TRANSPORTATION**

The documents used in transportation are proofs and contracts which validate the movement of goods from one place to another. Documents are part of proofs that

provide details of the quantity, time and nature of delivery. The different documents which are used in transportation are as follows:

- **Bill of lading:** A bill of lading is a contract which stands as a proof that it is the carrier's responsibility of loading the goods for delivery. This document contains all the relevant details regarding the goods which are being transported, the details and name of the ships which are used and the details of the ports to which it will be delivered.

This document provides the right to the carriers to take goods from one place and deliver it to the specified customer at some other place. Any damage, theft or loss of goods in between is the responsibility of the carrier. It is the carrier's responsibility of delivering the goods only to those customers who possess the bill of lading at the point of receiving the goods. He cannot provide the goods to anybody else without this document. This document can be transferred by way of endorsement.

- **Consignment note:** A consignment note is a document that certifies that a particular carrier will be responsible for carrying goods. This document requires a valid signature of the carrier. This consignment note must be created with respect to the form established by the "Convention on the Contract for the International Carriage of Goods by Road."
- **Sea Waybill (SWB):** A sea waybill is a document that only shows the receipt of goods. It is signed by persons who are responsible for transporting goods via seaports. The details mentioned in this document are the name of the person who is carrying the goods, the name of the person who has initiated the transport, the name of the port from where goods have been shipped, the name of the port where goods will be disembarked and the name of the recipient who will be receiving the goods at the destination. This document is non-transferable when compared to the bill of lading, which can be transferred.
- **Air Waybill (AWB):** An air waybill is a document that serves as proof of the contract of the carrier. This document establishes the responsibility of the carrier to carry goods from one place to another by air. This document also explicitly mentions the prices. It clearly states that the goods will be effectively transferred once they enter the flight. This document is standardised by the International Air Transport Association (IATA).
- **Rail Consignment Note:** The rail consignment note is also referred to as the International Consignment Note. This document is a proof which specifies that a particular rail carriage is responsible for taking the contract of delivering goods. This is again a non-transferable document.
- **Delivery order:** A delivery order is a document which states that a particular goods carrier has been ordered and the responsibility of delivery of goods is accepted. The owner of the carrier allows the release of goods from one place by signing a contract or a document which is known as the delivery order.
- **Dock receipt:** A dock receipt is a document which states that goods have been received by the carrier. This forms as a proof of the goods being ready for shipment. This document specifies the responsibility of goods having been transferred by

**NOTES**

the shipper to the carrier. This document is used as a proof in preparing a bill of lading.

- **Shipping guarantee:** A shipping guarantee is a document that is provided by the banks in writing, stating the safety of goods as a joint responsibility of the importer and the carrier. The importer is responsible in transferring this note to the carrier of goods.
- **Packing note or list:** A packing note is nothing but a detailed invoice that is attached to the goods. This note provides information regarding transportation details such as the mode, the origin, the destination, the details of the carriers, date of transport, expected date of delivery, etc. Except, for the price of goods, all other details are mentioned in this note. A copy of this note is shared with the receiver of the goods so that he can check and compare the details with the actual delivery.
- **Proof of delivery (POD):** A proof of delivery is a document which states that the goods have been received by the customers. The customers, after receiving the goods, are required to sign this document after going through all the details of the invoice, the packing note and comparing it with the actual goods. Whether he is satisfied with the delivery or not, this document states the same.

**SELF ASSESSMENT QUESTIONS**

7. A proof of delivery is a document which states that the goods have been received by the customers. (True/False)
8. POD stands for \_\_\_\_\_.
9. Match the following terms in List 1 and List 2:

List 1	List 2
1. Packing Note	a. a document which is provided by the banks in writing, stating the safety of goods as a joint responsibility of the importer and the carrier.
2. Rail Consignment Note	b. a document which states that the goods have been received by the customers.
3. Air Waybill	c. a non-transferable document.
4. Shipping Guarantee	d. a document that establishes the responsibility of the carrier to carry goods from one place to another by air.
5. Proof of Delivery	e. a detailed invoice that is attached with the goods.

- a. 1-e, 2-c, 3-d, 4-a, 5-b
- b. 1-e, 2-c, 3-b, 4-d, 5-a
- c. 1-c, 2-e, 3-d, 4-a, 5-b
- d. 1-e, 2-a, 3-d, 4-c, 5-b

### 3.6 SUMMARY

#### NOTES

- Transportation is the movement of goods and people from one place to another and is the most vital element of a country's economic, social and commercial growth.
- There are different modes of transport which include road, pipeline, rail, air, sea and multi-model transport.
- Various factors which influence transportation are terminal facilities, vehicles, fuel costs, government regulations, transit time, routes and sectional capacities, distribution pattern and nature of product.
- Trains help in carrying goods and people from one place to another in a short period of time.
- Railways form an integral part of the economic progress of a country because it mobilises people as well as goods.
- Some organisations hire their own freight forwarding companies which helps them in reducing such costs by providing an interface between different modes of transport.
- Some goods directly reach the customers from the warehouse, while some are distributed to the wholesalers, retailers and then to the final consumers.
- Air transport brings together the economies of different countries and helps in the integration of international trade and commerce.
- It is the carrier's responsibility of delivering the goods only to those customers who possess the bill of lading at the point of receiving the goods.
- The distance between the storage place or the warehouse to that of the customers or the suppliers determines the time in which goods can reach the ones who most need it.
- Terminal facilities mean all of the required land, infrastructure and equipment which are very important for operations in a warehouse.
- Terminal facilities are all used for the accommodation of products as storage places as well as for transport facilities of those products.

### 3.7 KEY WORDS

- **Multi-Model Transport:** It is a system where more than one mode of transport is used in order to deliver goods to the customers. It is a combination of two or more modes of transportation.
- **Air Waybill (AWB):** It is a document that serves as proof of the contract of the carrier. This document establishes the responsibility of the carrier to carry goods from one place to another by air. It also mentions the prices.

## NOTES

- **Consignment Note (CMR):** It is a document that certifies that a particular carrier will be responsible for carrying goods. This document requires a valid signature of the carrier.
- **Rail Consignment Note (CIM):** It is also referred to as the International Consignment Note. This document is a proof which specifies that a particular rail carriage is responsible for taking the contract of delivering goods.
- **Proof of Delivery (POD):** It is a document which states that goods have been received by the customers.

### 3.8 CASE STUDY: KITE SAILING CARGO

#### Background

When Calvin Harris was 16 years old, he was inspired by the concept of kite sailing which used the power of the wind to move kites in new ways. In the year 2002, when Calvin completed his degree of engineering, he started a company of his own which he named as SkySails in the same year. The basic idea of this company was moving ships using a wind-powered kite.

With the use of wind as a power to drive ships, the use of fuel gets reduced and eventually costs go down by 10% to 35%. The biggest advantage of using wind power was that greenhouse emissions were reduced because of the reduction in the use of fuel.

This wind-power was initially tested in small ships. Slowly and steadily, the idea was used in moving small cargo ships from one place to another. Later, in the year 2008, this idea was eventually used in moving full-fledged cargo ships.

#### Problem

The increase in the prices of fuel and the environmental effects of using fuel have created challenges in finding solutions in meeting the energy requirements. There is an expectation of oil prices to go up by 100% by the year 2025 because of the fall in the supply of the same. SkySails has a plan of sailing up to 1,600 cargo ships, fish trawlers by the year 2020 and up to 12,000 cargo ships by the year 2025.

#### Solution

The application of the idea used by SkySails and other similar technologies by other companies might bring down the need for use of fossil fuels. SkySails with its application of idea has brought about a modern twist to the ancient solution. With the use of such ideas, the impact of sailing goods at a global level can be reduced.

#### Results

By using the idea of SkySails, carbon emissions from moving cargo ships have reduced by 160 million tonnes each year.

SkySails have won numerous awards for its idea in the year 2005 and Calvin Harris was awarded for being the Most Outstanding Person of the Year in the year 2005 for his innovative idea.

## QUESTIONS

- Which form of transport is being discussed above? Explain in brief.  
(**Hint:** Kite sailing which used the power of the wind to move kites.)
- Write down the facilities provided by this mode of transport.  
(**Hint:** By the year 2008, this idea was eventually used in moving full-fledged cargo ships.)
- How has the application of using wind-power idea helped SkySails?  
(**Hint:** Carbon emissions from wind-power have reduced by 160 million tonnes each year.)
- What is the problem with the traditional method of cargo shipping?  
(**Hint:** Increase in the prices of fuel and the environmental effects.)

## 3.9 EXERCISE

- What do you mean by transportation?
- Briefly explain the following:
  - Rail transport
  - Multi-model transport
  - Pipeline transport
- What are the factors which influence transportation?
- What are various documents used in transportation? Explain.
- Explain in brief transportation by road and its advantages.

## 3.10 ANSWERS FOR SELF ASSESSMENT

Topic	Q. No.	Answer
Concept of Transportation	1.	True
	2.	infrastructures
Modes of Transportation	3.	False
	4.	road
Factors Influencing Transportation	5.	True
	6.	Terminal facilities
Documents Used in Transportation	7.	True
	8.	Proof of Delivery
	9.	a. 1-e, 2-c, 3-d, 4-a, 5-b

## 3.11 SUGGESTED BOOKS AND E-REFERENCES

### SUGGESTED BOOKS

- Faulin, J., Grasman, S., Juan, A., & Hirsch, P. (2018). *Sustainable Transportation and Smart Logistics*.
- Fahimnia, B., Bell, M., Hensher, D., & Sarkis, J. (2017). *Green Logistics and Transportation*.

### E-REFERENCES

- Logistics Management, 2nd Edition. (2019). Retrieved 30 September 2019, from <https://www.oreilly.com/library/view/logistics-management-2nd/9788131727546/xhtml/chapter008.xhtml>
- Transport documents. (2019). Retrieved 30 September 2019, from <https://logistics.public.lu/en/formalities-procedures/required-documents/cargo-documents.html#>

# Containerisation

## Table of Contents

---

- 4.1 Introduction**
- 4.2 Concept of Containerisation**
  - 4.2.1 Need for Containerisation
    - Self Assessment Questions
- 4.3 Benefits of Containerisation**
  - Self Assessment Questions
- 4.4 Types of Containers**
  - 4.4.1 General Purpose Containers
  - 4.4.2 Specific Purpose Containers
    - Self Assessment Questions
- 4.5 Disadvantages of Containerisation**
  - Self Assessment Questions
- 4.6 Summary**
- 4.7 Key Words**
- 4.8 Case Study**
- 4.9 Exercise**
- 4.10 Answers for Self Assessment Questions**
- 4.11 Suggested Books and e-References**

**LEARNING OBJECTIVES**

*After studying this chapter, you will be able to:*

- Explain the concept and meaning of containerisation
- Discuss the need for containerisation
- Explain the benefits and challenges of using containers in moving cargoes
- Outline different types of containers used in this system
- Describe the disadvantages of containerisation

**4.1 INTRODUCTION**

In the previous chapter, you studied about the concept of transportation, various modes of transportation and how each method is different from the other. At last, the chapter also discussed factors that influenced transport and documents used in transport.

The practice of carrying goods from one place to another in standard shapes and sizes of containers is known as containerisation. Containers are prepared in such a way that it can store almost anything in it and are used for the transport of manufactured goods in particular. The use of containers has enhanced carrying of goods and products and has made distribution easier. People who are involved in the export of goods are not required to physically visit the seaports for sending goods. They send their goods to the Inland Container Depot (ICD), which are also known as container freight stations, which finally sends the goods to the ultimate destination.

Use of containers for the export of goods came in place only after the enactment of the Multi-modal Transportation of Goods Act, 1993. Packing and loading of goods can be done either at the exporters place or at the inland container depot itself. A multimodal transportation document is issued to the exporter which is equivalent to that of a bill of lading document, which is required for the transportation of goods. An exporter saves a lot of time because all the customs clearance services are provided at the ICD.

The overall process of containerisation entails packing goods and products in suitable containers at the place where goods are produced rather than taking to the quayside and then pack. Then, the packed goods are transported through road or rail to the port. Once they reach the port, cranes are used to load and unload containers from and off the ship.

The use of traditional methods of transporting goods with the help of stevedores and porters has gone obsolete after containerisation came in. By the use of containers, huge quantities of goods can be moved from one place to another more quickly. Not only this, it has also helped reduce the use of manpower, which means only a few workers are to be paid. The time spent on the ports for loading and unloading goods is also reduced with the use of containerisation. The overall savings of the shipping

firms have increased. More time is spent in building new ships which can carry higher loads of containers.

In this chapter, you will study about the concept of containerisation, and its needs and advantages. The chapter describes the types of containers, namely general purpose containers and specific purpose containers. Later on, the chapter also discusses the disadvantages associated with containerisation.

## 4.2 CONCEPT OF CONTAINERISATION

Containerisation is a system wherein intermodal freight is transported by using intermodal containers of standard sizes and shapes. These containers can be easily loaded, unloaded and reloaded at different modes of transport without even opening it. Containers are not handled manually by the labour but are completely mechanised. Different forms of cranes and forklift trucks are used to load and unload the containers. Moreover, all the containers are given unique identification numbers and their movement is tracked by the use of computerised systems.

The system of containerisation was established long ago in 1930s, where movement of cargo was carried out using primitive methods in the North Atlantic coastal tracks. At this point, the boxes in which goods were carried were known as van ships.

The concept of containerisation gained importance in 1955 when Malcolm McLean came up with a new idea of shipping goods. In this method, the body of the lorry was removed from the vehicle carrying it. It was then lifted and placed onto the deck of the ship. This completely removed the manual work of the labour in handling cargo.

In the year 1965, metal containers were introduced, which could be detached from the lorry body itself. In the same year, several ships carrying containers were moving across the Atlantic for transportation of goods. Since containers were of standard sizes, there were no constraints on type of containers and the ships by which it should be carried.

By the year 1967, ships carrying both the loose products in its hold and containers on its deck were used to transport cargo which gave way to the movement of huge number of boxes at a single point of time.

Cranes were available which were used for loading and unloading containers. This led to a reduction of shipping costs as only a few workers were required in place of hundreds to efficiently load and unload containers. In order to protect items in the containers, wooden cranes were used which protected the goods from damage.

Gradually, the concept of containerisation gained importance. All the organisations involved in the shipping industries are efficiently using this system of moving cargoes because it has helped them in various ways. Moreover, with the changes in technologies, containers and their movement are tracked at every single place, from the pickup and delivery point to the point of its destination by the use of computer systems.

## International Container Shipping Process

For a better understanding of the process of containerisation in transportation and shipping, the process chart given below explains how shipments are exported from India.

The participants involved in this whole process are as follows:

- **Importers:** Importers are just a normal buyer. When they feel the need for something specific, they look out for the best supplier around the world, which can provide them with the best product. Once importers identify the supplier, they place an order for the purchase.
- **Exporters:** Exporters, on the other hand, are the sellers. They are the ones whom the buyers contact and ask for the supply of goods.
- **Banks:** Banks are third parties who have a very important role to play in the whole process of container shipping. They negotiate the contract between the buyer and the seller, support them with finances, majorly control the goods and provide documentation.
- **Insurance organisations:** The most crucial players of this entire container shipping process are the insurance organisations. They are the ones who help in covering the risks, which forms a part of transportation.
- **Freight forwarders:** These freight forwarders are the mediators between the seller and the buyer. They are involved in the logistic activities and with other parties involved in the process which needs to be taken care of in the process of export or import.
- **Customs House Agents (CHA):** They are people who provide custom clearance to the goods from the custom authorities.
- **Shipping organisations:** Shipping organisations are the owners of the ship or the carrier which actually carries goods from the port to its destined place.
- **Customs:** Customs authorities are bodies which provide custom clearance to the goods exported or imported. Presence of two customs authorities in an international trade is a must— one from the country which is exporting the goods and one from the country which is receiving or importing the goods.
- **Port authorities:** Port authorities are somewhat similar to that of customs authorities. They provide clearance for goods to be loaded onto a ship (port authorities of the country which is exporting) and clearance for goods which are to enter the country (port authorities of the country which is receiving or importing.)
- **Intermodal transport providers:** The intermodal transport providers are bodies which facilitate the movement of cargoes/containers from the place of production or warehouse to the ports and also from the ports to the final destination of the cargoes of goods. These involve rail and road transport providers.

A step-by-step guide to the International Container Shipping Process is shown in Figure 1:

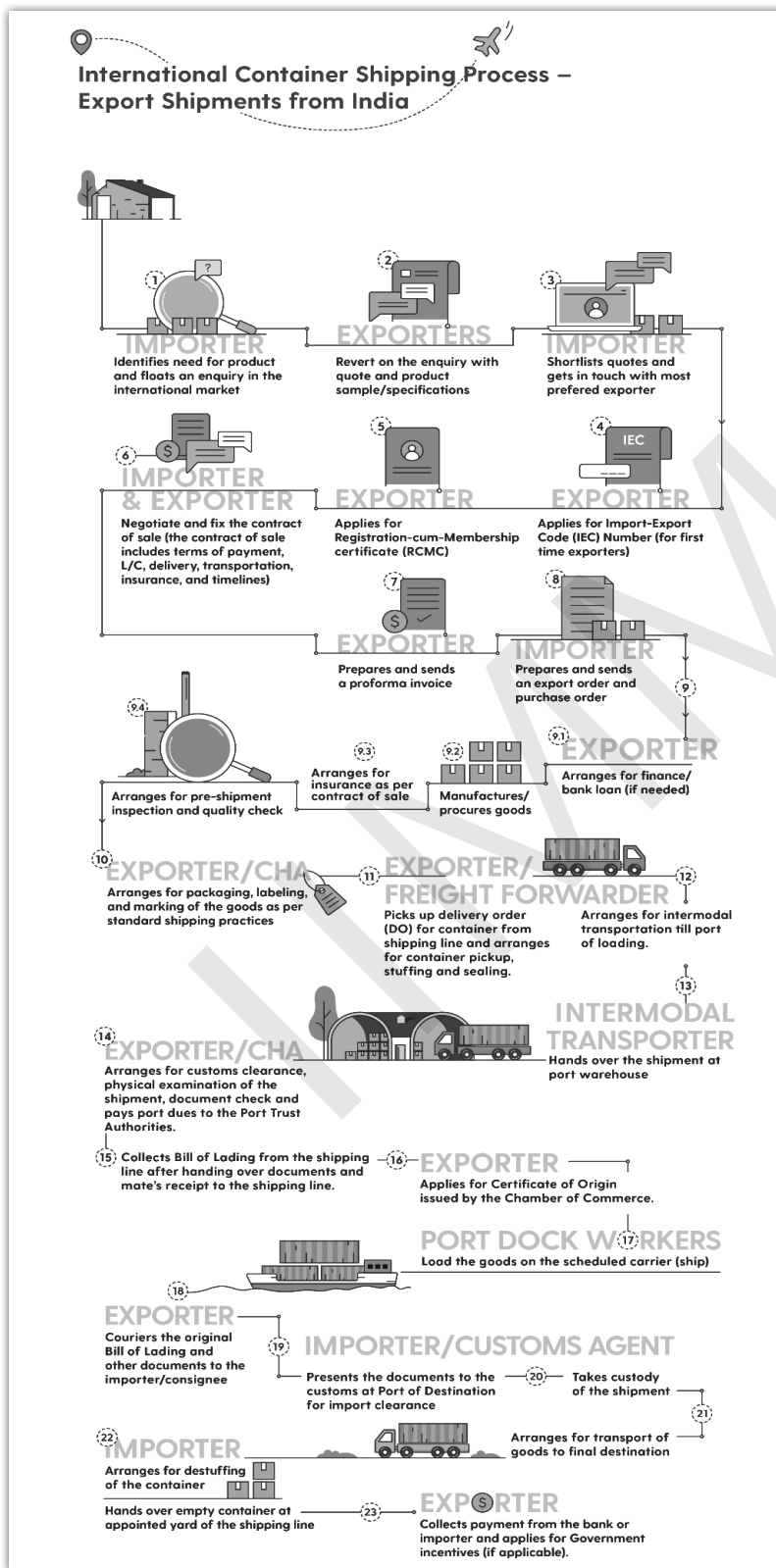

FIGURE 1: A Step-by-Step Illustration of the Shipping Process

Source: <https://www.cogoport.com/blogs/industry-basics/export-process-from-india>

### 4.2.1 | NEED FOR CONTAINERISATION

The purpose of logistics is to move the right product to the right place at the right time with the right price. All the leading organisations in today's world are working towards efficiency of its supply chain by using the most feasible technologies and support. Improvement in performance is what organisations need the most.

One such method or technology which organisations use is containerisation where they move their products in containers. Containerisation plays a vital role in the downstream process of transportation in logistics, as well as in the upstream process of the supply chain management. Containerisation helps the shippers in building the most adequate and efficient capacity of containers, in order to move heavy loads of cargo from one place to another considering all challenges such as stacking rules, crush factors and orientation.

For organisations which are involved in moving products of varying weight, containerisation is highly beneficial for them. Both heavy and light-weight products can be shipped together if the entire holding capacity of a container is utilised. This results in less use of resources and also a limited number of containers can be used in order to move the same quantity of cargo.

Containerisation is the main cog of the whole multimodal transport system because it is easily adaptable in this form of transport and also facilitates international commerce. It bridges the time gap between two modes of transport by quickly moving cargoes from one mode to another. This helps in the integration and standardisation of the whole system of freight cargo movement.

Thus, containerisation has brought all the modes of transport together to a common field along with bringing in revolutionary changes in the system of shipping moving cargoes across the countries. At present, containerisation has gained much importance, wherein the government of India is also supporting and helping it work efficiently by investing time in the construction of the road networks in the whole country.

Moreover, containerisation helps in the logistics management of countries, such as Nepal, Bhutan and other states of northern India, which are surrounded by land from all sides, apart from the coastal region states where international trade is carried out substantially in containers.

#### SELF ASSESSMENT QUESTIONS

1. The practice of carrying goods from one place to another in standard shapes and sizes of containers is known as \_\_\_\_\_.
2. All the containers are given unique identification numbers and their movements are tracked by the use of computerised systems. (True/False)

### 4.3 | BENEFITS OF CONTAINERISATION

Containerisation has helped shipping organisations in moving cargoes efficiently from one place to another. It protects goods from damage and pilferage. It is because of containerisation that shipping organisations are able to move a large number of

goods at a single point of time by utilising the overall capacity of containers. Various advantages of containerisation are as follows:

- **Standardisation:** One of the main advantages of containerisation is standardisation. Each container is given a unique identification number and a code which defines its size. ISO standard modes and equipment are used to handle standard transport products at every stage of its movement.
- **Flexibility:** Another important benefit provided by containerisation is that it is used to carry goods of different shapes, sizes, quality and nature. Commodities, as well as manufactured goods, can be easily moved. Even liquid products can be moved with ease by using containers. There are different kinds of containers available for different types of goods and commodities. Anything from wheat, coal, cars, refrigerators to oils and gases can be moved by using containerisation.
- **Costs:** The cost of transport is reduced by using containerisation. As compared to the traditional means of moving commodities, containers are 20 times less expensive. Economies of scale is achieved at different terminals and modes due to containerisation, which was not the case in the conventional systems.
- **Warehousing:** The containers are in themselves moving warehouses of products. Containers act as a storage place for commodities where products are safe and protected. There is no need for extra packaging of the goods since containers are the safest package. The holding capacity of containers on ground, trains and ships are huge and highly advantageous for organisations.
- **Security and safety:** The products which are being carried by containers remain safe in the entire shipment. These containers are packed in such a way that nobody can identify what kind of and how much goods are being carried by it. Containers can only be opened at its destination, and nowhere in between. This protects the goods from theft and loss.
- **Velocity:** By employing containerisation in operation, organisations can confidently produce goods and commodities which can fully utilise the space of the containers. This eliminates the underutilisation of the shipping space. The ability of the containers to carry more loads enhances the process of distribution of goods.

#### SELF ASSESSMENT QUESTIONS

3. Each container is given a \_\_\_\_\_ identification number and a code which defines its size.
4. Compared to the traditional means of moving commodities, containers are 20 times expensive. (True/False)

## 4.4 TYPES OF CONTAINERS

The containers which carry cargoes are a kind of waterproof rectangular boxes which are used to move goods efficiently without damaging them. The types of containers are usually classified in terms of the type of cargo which it carries. These types are as follows:

- General purpose container
- Specific purpose container

#### 4.4.1 | GENERAL PURPOSE CONTAINERS

These types of containers are the most common types which are used for shipping. They are made up of steel and one can easily find them stacked in several seaports. There are different sub-types of general purpose containers, which are as follows:

- **Dry containers:** These types of containers are fully covered from all sides and are like huge boxes standardised by ISO which carry goods in themselves. They are used for carrying dry products and usually come in sizes of 10, 20 and 40 feet.
- **Open-top containers:** These types of containers come with a top which can be easily removed. Products of various sizes in terms of height can be easily shipped by using open-top containers.
- **Flat-rack containers:** These types of containers come with detachable and collapsible sides. This means that the sides of these containers can be folded or detached to make more space where different kinds of goods can be placed and shipped.
- **Closed ventilated containers:** These types of containers are used for the purpose of protecting the goods from a high level of humidity and moisture in the external environment. These containers are properly ventilated to let the air pass, in order to keep the dry products from getting stale. These containers are usually used for dry food products.

#### 4.4.2 | SPECIFIC PURPOSE CONTAINERS

Specific purpose containers are used for the purpose of carrying goods, like food items, frozen products or perishable commodities. The different types of containers used for specific purpose are:

- **Thermal containers:** These types of containers are also known as reefers. These are insulated from inside and outside to protect the commodities from the external environment and temperature. There are devices which control the temperature of the containers.
- **Insulated shipping containers:** These are kind of thermal containers, the only difference being that there are no devices used for controlling the temperature in these containers. The interior insulation is enough for maintaining an ambient temperature inside to protect the goods.
- **Refrigerated shipping containers:** The temperature inside these types of containers is regulated by iceboxes or liquified gases. There is no need for power supply from any external source to keep the temperature cold in order to protect the goods.
- **Mechanically refrigerated containers:** These types of containers come with temperature regulation and require an external supply of power to maintain the temperature. The temperature inside can be kept to a minimum requirement so as to keep perishable goods like fruits, vegetables, etc., in a good condition for a longer period of time. These are specifically used for perishable products only.

- **Heated containers:** These types of containers are used for goods which are required to be kept at a higher temperature to keep them safe. External power supply source is used to maintain the temperature of the container.
- **Named cargo containers:** These containers are used to transport products, such as cars, poultry, livestock and other such specific commodities.
- **Dry bulk containers:** These containers are used for the purpose of transporting products which do not require any kind of external packaging, such as grains and other dry foodstuffs.
- **Tank containers:** These containers are typically used for storage and transport of liquid products. They are made up of strong steel and anti-corrosive materials to keep the liquids inside protected from any kind of external wear and tear.

#### SELF ASSESSMENT QUESTIONS

5. \_\_\_\_\_ containers are also known as reefers.
6. Heated containers are used for goods that are required to be kept at a higher temperature to keep goods safe. (True/False)

## 4.5 DISADVANTAGES OF CONTAINERISATION

There are always areas of challenges which prevail in every aspect of commerce. Every concept has its own pros and cons. We have already discussed the benefits of using containerisation as a system of moving cargoes. Now, there are some points where shipping industries face challenges in using containerisation. They are as follows:

- **Site constraints:** Since containers are huge in sizes, bigger spaces are required for them to be stored. This means that the terminal storage spaces should be enough to hold these containers. This is the reason why many of the intermodal terminals have been moved to the urban areas where there are more spaces available. Moreover, most of the ports are experiencing issues with the advancement of containerships because a single post-Panamax containership requires at least 13 metres of space.
- **Capital intensiveness:** A huge amount of investment is required in order to handle containers. Resources, such as infrastructures and additional equipment such as cranes, rail access, inland roads and warehouses should be readily available in order to adapt to containerisation. Moreover, since automation is becoming an integral part of organisations today, the intensity of these capital investments is increasing.
- **Stacking:** The area of terminal spaces differs and there arises the problem of stacking the containers. The containers which are properly arranged on the ground are required to be rearranged when placing them on containerships. This leads to re-stacking and double-stacking of containers. These rearrangements cannot be avoided and it incurs additional costs for the operators in different terminals.

NOTES

- **Repositioning:** It is not necessary that all the containers carry with themselves 100% of load. There are containers which move half-empty, while there are some which does not carry anything with them. There is a huge difference in the level of production and consumption of commodities on the global front which requires repositioning of the goods in the containers over long distances of its travel.
- **Theft and losses:** At times, it may happen that a unit of container load can be opened by force and the goods available in them can be carried away in trucks. This might also happen with high-value goods and lead to huge losses. Also, at times, some containers from overloaded ships may fall off into the sea before reaching its destination. Hence, many cases of lost containers are registered every year.
- **Illicit trade:** Containerisation, to some extent, has given an advantage to illegal traders in the world who trade illegal products such as drugs, weapons, etc. with the use of containers. It is being assumed that terrorism is also being facilitated but there are no such recorded cases for this. No matter how many loopholes there are in this concept, one can always work upon them and derive benefits by resolving such issues. There will always be new challenges coming up, but to overcome such barriers is what is needed to make a system more efficient and effective. Containerisation has helped organisations far more than the presence of such challenges.

SELF ASSESSMENT QUESTIONS

7. The area of terminal spaces differs and there arises the problem of \_\_\_\_\_ the containers.
8. A huge amount of investment is required in order to handle containers. (True/False)
9. Match the following:

List 1	List 2
1. Thermal Containers	a. are typically used for storage and transport of liquid products
2. Named Cargo Containers	b. are those types of containers which comes with detachable and collapsible sides
3. Tank Containers	c. are insulated from inside and outside to protect the commodities from the external environment and temperature
4. Flat Rack Containers	d. are people who provide customs clearance to the goods from the customs authorities
5. Customs House Agents	e. are used to transport products, like cars, poultry, livestock and other such specific commodities

- a. 1-a, 2-b, 3-c, 4-e, 5-d
- b. 1-d, 2-e, 3-c, 4-b, 5a
- c. 1-a, 2-e, 3-c, 4-b, 5-d
- d. 1-c, 2-e, 3-a, 4-b, 5-d

**4.6 SUMMARY****NOTES**

- The use of traditional methods of transporting goods with the help of stevedores and porters have gone obsolete after containerisation came in. Through the use of containers, huge quantities of goods can be moved from one place to another more quickly.
- The system of containerisation was established long ago in 1930s, where movement of cargo was carried out using primitive methods in the North Atlantic coastal tracks.
- All the leading organisations in today's world are working towards efficiency of its supply chain by using the most feasible technologies and support.
- With the changes in technologies, containers and its movements are tracked at every single place by the use of computer systems from the pickup to the point of its destination.
- All the leading organisations of the world are working towards efficiency of its supply chain by using the most feasible technologies and support.
- The practice of carrying goods from one place to another in standard shapes and sizes of containers is known as containerisation. Containerisation is a system wherein intermodal freight is transported by using intermodal containers of standard sizes and shapes.
- Use of containers for the export of goods came in place only after the enactment of Multimodal Transportation of Goods Act, 1993.
- The use of containers has enhanced carrying of goods and products and has made distribution easier. People who are involved in the export of goods are not required to physically visit the seaports for sending goods. They send their goods to the Inland Container Depot (ICD) which are also known as container freight stations and who sends the goods to the ultimate destination.
- Gradually, the concept of containerisation gained importance. All the organisations involved in the shipping industries are efficiently using this system of moving cargoes because it has helped them in various ways.
- Containerisation helps in the logistics management of countries, such as Nepal, Bhutan and other states of northern India, which are surrounded by land from all sides,
- Containerisation is the main cog of the whole multimodal transport system because it is easily adaptable in this form of transport and also facilitates international commerce.
- Containerisation bridges the time gap between two modes of transport by quickly moving cargoes from one mode to another. While doing this, it helps in the integration and standardisation of the whole system of freight cargo movement.

## 4.7 KEY WORDS

- **Tank containers:** They are typically used for storage and transport of liquid products. They are made up of strong steel and anti-corrosive materials to keep the liquids inside protected from any kind of damage.
- **Named cargo containers:** They are used to transport products, such as cars, poultry, livestock and other specific commodities.
- **Insulated shipping containers:** These are types of thermal containers, the only difference being that there are no devices used for controlling the temperature in these containers. The interior insulation is enough for maintaining an ambient temperature inside to protect the goods.
- **Thermal containers:** These types of containers are also known as reefers. They are insulated from inside and outside to protect the commodities from the external environment and temperature. There are devices which control the temperature of the containers.
- **Customs House Agents (CHA):** They are people who provide custom clearance to goods from the custom authorities.

## 4.8 CASE STUDY: CUSTOMISATION OF CONTAINERS

Phoenix Containers is one of the leading organisations which is involved in the supply of shipping containers to its various clients of different industries. Moreover, it also helps their clients in the modification of the existing containers to cater to their needs.

One of their clients came up to them with an idea of having a container which could be used to clear out their warehouse goods in order to make extra space for new commodities. The client's existing warehouse included products which were of highly perishable nature and were extremely expensive. They wanted to have a container which could protect their goods from the frequent changes in temperature in the external environment and could keep their goods safe. They wanted an airtight container to secure their goods. Apart from this, they also wanted to have enough side spaces on the container so that their cranes and forklift trucks were able to load goods with ease and place them into the container.

Phoenix Containers discussed with their clients and came up with a container most suitable for them. The client was provided with a container 40 ft in size. One of the sides of the container was removed and replaced with a curtain-type sliding door which was fitted with the top rail of the container. It was set up in such a way that this side was easily accessible.

After using this type of container, the client was extremely happy and placed an order for extra containers of the same specifications. They also discussed further orders related to their different needs and requirements.

### QUESTIONS

1. Explain in brief the type of container used in this case study.

(**Hint:** Flat rack containers are those types of containers which come with detachable and collapsible sides.)

2. What are the benefits of using this type of container as suggested by the organisation?

(**Hint:** Flat rack containers are those types of containers which comes with detachable and collapsible sides.)

3. Explain other types of containers which can be used for dry products.

(**Hint:** Closed ventilated containers are properly ventilated to let the air pass, in order to keep the dry products from getting stale.)

4. List down the disadvantages of containerisation.

(**Hint:** Containerisation requires high capital investments, stacking, site constraints, repositioning, theft and losses, etc.)

## 4.9 EXERCISE

1. Explain the meaning and concept of containerisation.
2. Why do you think there is a need for containerisation?
3. What types of containers fall under specific purpose containers?
4. Write down different types of containers under general purpose containers.
5. List down the participants involved in the container shipping process.

## 4.10 ANSWERS FOR SELF ASSESSMENT QUESTIONS

Topic	Q. No.	Answer
Concept of Containerisation	1.	containerisation
	2.	True
Benefits of Containerisation	3.	unique
	4.	False
Types of Containers	5.	Thermal
	6.	True
Disadvantages of Containerisation	7.	stacking
	8.	True
	9.	d. 1-c, 2-e, 3-a, 4-b, 5-d

## 4.11 SUGGESTED BOOKS AND E-REFERENCES

### SUGGESTED BOOKS

- Levinson, M. (2016). *The Box. How the Shipping Container Made the World Smaller and the World Economy Bigger?*
- Lun, Y., Lai, K., Wong, C. and Cheng, T. (2017). *Green Shipping Management.*

**E-REFERENCES**

- *Classification of Containers - Tutorial*. [online] Available at: <https://www.vskills.in/certification/tutorial/international-logistics/classification-of-containers/> [Accessed 1 Oct. 2019].
- The Geography of Transport Systems. (2019). *Advantages and Drawbacks of Containerisation*. [online] Available at: [https://transportgeography.org/?page\\_id=2638](https://transportgeography.org/?page_id=2638) [Accessed 1 Oct. 2019].



# Container Freight Stations

## Table of Contents

---

- 5.1 Introduction
- 5.2 Concept of Container Freight Stations
  - 5.2.1 Functions of CFS
  - 5.2.2 Benefits of CFS
    - Self Assessment Questions
- 5.3 Approval of CFS – Guidelines and Implementation
  - Self Assessment Questions
- 5.4 Role of Container Corporation of India Limited in Logistics
  - 5.4.1 Functions of CONCOR
    - Self Assessment Questions
- 5.5 Summary
- 5.6 Key Words
- 5.7 Case Study
- 5.8 Exercise
- 5.9 Answers for Self Assessment questions
- 5.10 Suggested Books and e-References

**LEARNING OBJECTIVES**

*After studying this chapter, you will be able to:*

- Explain the meaning and role of container freight stations
- Describe the concept of CFS and the pre-requisites of setting up of CFS
- Explain the procedure of submitting applications for setting up of CFS
- Outline the benefits and functions of CFS
- Discuss the role of Container Corporation of India Limited in logistics

**5.1 INTRODUCTION**

In the previous chapter, you studied about the concept of containerisation and its need. The chapter also gave an insight into the benefits associated with containerisation. It also discussed different types of containers used, namely general purpose and specific purpose containers. In the end, the chapter described the disadvantages of containerisation.

Container freight stations or CFSs are facilities where cargo containers or freight shipments are stacked, de-stacked and handled between different modes of transport. It is basically a place where cargo containers are moved and transported from the production houses to the ports and from the ports to their destination. They are situated at a place which is easily accessible by the exporters/importers and the ports which are involved in the shipment of the cargo containers.

Before directly transporting the manufactured goods to the ports for the purpose of export, the production houses keep their goods at CFSs where they are consolidated and stacked in accordance with the requirement of the shipping lines. Subsequently, stacked goods are then sent to the ports for export. Similarly, in cases where goods are to be imported, the shipping lines transport the imported cargo containers to the CFSs. The CFSs then send those goods to their destined places after proper examination and consolidation.

Container freight stations play a very important role in the Less than Container Load (LCL) shipping. When a CFS receives a cargo container with less than its load, it waits for another stack of cargo containers. Until and unless cargo container uses all the extra spaces left in the LCL by stacking extra goods in it, it does not send the vehicle to the port. It acts as a warehouse for the production houses who store their goods at CFSs for its safety.

Moreover, CFS takes responsibility of all the additional activities required in order to export or import goods. Major services like customs clearance is provided by the CFS. They are the first point of contact for all custom-related queries. The production houses and the ports do not have to waste their time in the customs clearance activity as all the goods which come into the CFSs are moved only after they are customs-cleared.

A successfully running CFS has skilled professionals who are engaged in managing the operations taking place at CFS. These professionals make sure that the goods are stored safely and shipped efficiently.

In this chapter, you will study about the concept of freight stations, its functions and benefits. The chapter will elucidate on approval of CFS along with guidelines and implementation. Further on, the chapter will underscore the role of Container Corporation of India Limited in logistics.

## 5.2 CONCEPT OF CONTAINER FREIGHT STATIONS

Container freight stations, commonly known as CFS, are centres of multimodal logistics system wherein cargo containers and customs are handled. These stations are directly connected to the seaports by way of roads or rails and are a point of transshipment for exports and imports of all sorts of goods. Apart from this, these stations also help organisations by handling and storing their export/import goods as well as the empty containers on a temporary basis. These stations are located at places which are away from the ports so that the cargo and customs are handled separately with ease which avoids congestion at the serving ports. They provide just the right type of infrastructure where containerised cargo can be kept and where export and import can be handled properly.

A pictorial representation of Container Freight Station (CFS) is depicted in Figure 1:

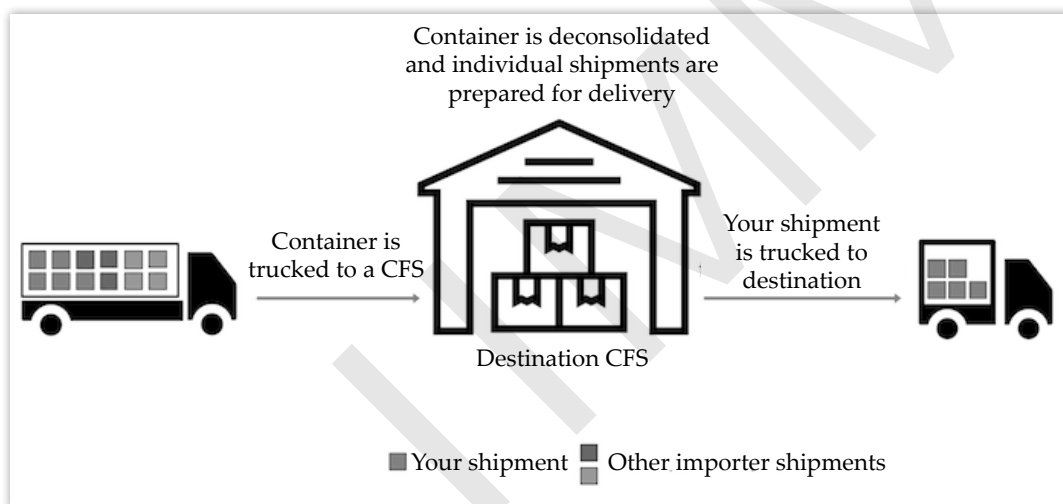

FIGURE 1: Container Freight Station (CFS)

Source: <https://www.flexport.com/glossary/container-freight-station>

### Privatisation

The operations of CFS were privatised after a decision taken vide Circular No.128/95-Cus dated 14<sup>th</sup> December, 1995. The basic reason for bringing in the private sector was to enhance the development of the infrastructure at a place away from the gateway ports in order to avoid congestion at the seaports, because of the widespread economic growth and industrialisation in the countries.

To bring down the level of congestion at the ports of cities, the government opened CFSs inside the borders and at interior points of the country so that custom clearance could be done at various places inside the country itself. This encouraged foreign trade, export/import of goods to a great level. These CFSs provide all facilities at the

## NOTES

seaports, especially the facility of custom clearance. The idea was to give all the basic requirements to the organisations for their export and import activities.

In order to submit applications and proposals to set up CFSs by either the private or the public sector, prior clearance from the Inter-Ministerial Committee is a must. This clearance is given on the basis of the recommendations provided and shared by the jurisdictional Commissioner. The jurisdictional commissioner scrutinises the applications and proposals submitted by the private or public sector. He checks if the details and the information provided by the private or public sector abides the set guidelines. Only then private or public sector gets a clearance certificate.

Upon giving the clearance certificate, a letter of intent is handed over to the private or public sectors and they are asked to build the infrastructure in a stipulated period of time already mentioned in the letter. After the infrastructure is set up, the Jurisdictional Commissioner of customs examines the infrastructure and once the Commissioner is satisfied, he/she issues the party a notification under Section 8 of the Customs Act, 1962, which serves as the approval of the container freight station.

The operators of the CFSs are then declared as the custodians of the station who are required to present an undertaking that they are going to bear all the costs of the staffs which they will keep for the purpose of customs. These undertakings are supposed to be in sync with the terms of the Circular dated 14<sup>th</sup> December, 1995.

### Customs Officers in CFSs

The officers who are appointed as the guardians of the CFSs are required to monitor and provide customs clearance services for the export and import of goods and cargo.

Prerequisites of setting up of CFS are as follows:

- **Prior survey:** The success of CFSs depends on the total cost of transportation. Only when CFSs are able to reduce the total cost of transportation, one can say that they are working successfully in the country. This is because there is a possibility of an increase in the handling cost of the goods in order to move it from its place of origin to its place of destination.

The prerequisite for successful CFSs entails prior investigation, survey and R&D activities of the evaluation of traffic which is handled by these centres so that setting up of CFSs is economical. It is also to be considered that CFS activities do not affect the overall cost of the movement of goods negatively. There ought to be a report published which should include the application or proposal of setting up of CFSs.

A survey must be done by an external facility so that the data and information retrieved regarding CFC set-up is accurate and true in all respects. Before publishing the survey report, it must be fully reviewed by all the parties involved in the entire cycle of transportation, be it the exporters, the shipping lines, the customs commissioners, freight forwarders, etc.

- **In-principle approval by Jurisdictional Customs Commissioner:** Prior to making any sort of investment before setting up of the CFS or before submitting the

application, the parties must obtain an in-principle approval by the Jurisdictional Customs Commissioner who would confirm if investing on the project is feasible or not. A copy of this approval must be attached to the application to be submitted online.

The facilities provided by the CFSs must be economically beneficial to the users of this service. The users of this service include the railways and other transport operators, like seaports, freight forwarders, shipping industries, etc. All the users should experience a less amount of traffic after CFSs take responsibility of all the related activities. Therefore, all the prospective entrepreneurs are required to have a proper insight into the economic viability of the project.

- **Land requirements:** In order to set up a CFS for all export and import activities, there must be the availability of land with the minimum required area of one-hectare metres. However, if the area is in any way less than the minimum requirement, a justification for the same has to be provided. Less than the minimum requirement of area is possible when there are advanced technologies and upgradations in the activities. These standpoints have to be clearly mentioned and justified in the reports.
- **Design and layout:** A CFS should be well-equipped with all modern mechanical and electrical set-ups. The design and layout should be decided keeping in mind the smooth movement of the containers or vehicles through CFS. Apart from this, the volume of the business must also be taken into account. Not only the volume with which the business is to be started is to be taken care of, but also an expected rise in the volume in future. The layout should be such which easily adapts itself to the frequent changes in the circumstances of business. The design should be well-equipped with all the security features along with the basic features including rail sliding, pavements and roads, gatehouse, container yard, buildings with basic public amenities, etc.
- **Infrastructure:** In order for the CFSs to work efficiently, a strong connectivity of electronic data interface and a good communication system is necessary. The infrastructure of a CFS must have the following:
  - To support heavy-duty goods and equipment, a separate and standard pavement must be constructed to be used in the area of operation and stacking of the terminal.
  - To have a separate office building for the Inland Container Depot and customs. Also, a separate block must be constructed for the user agencies and it should be self-sufficed with all the basic amenities and facilities.
  - To provide a separate warehousing facility for goods and cargo which are bonded and which are to be stored for a long-term period.
  - To have gateways, exit and entry points must be constructed at separate ends of the set-up.
  - To extend parking facility that must be big enough for all vehicles which are waiting to enter the complex.
  - To have a boundary wall constructed as per rules specified by the customs.
  - To possess an electronic weighbridge.
  - To provide a separate computer set-up for electronic processing of all important documents and they must be capable enough to be linked to EDI.

### 5.2.1 | FUNCTIONS OF CFS

Container freight stations play a pivotal role in both importing and exporting. They act as a cynosure point for suppliers to send the products that have been ordered. CFSs act as a storing area prior to shipments of colossal, multimillion worth of goods that are transported. The functions of CFSs are as follows:

- These are involved in stuffing and de-stuffing of containers carrying goods and cargo in order to make them ready for export or import. With the advancement in international trade, it is very necessary for goods to be customs cleared in a very short frame of time. Also, this is important because the gateway ports face too much of congestion while providing all the facilities including that of custom clearance. Moreover, in order to have an optimal use of the infrastructure, the cargo which comes to the ports needs to be moved as quickly as possible without any delay. The importance of CFS facilities has increased with growth and development of the gateway ports.
- These are a part of inland container depots and are a place where goods and cargo which are to be exported and imported are kept till the time they get through the customs clearance. All the imported goods which come to the ports are immediately moved and placed at the CFSs so that the ports don't get congested. All the custom clearance activities for all the goods takes place at these stations. This is the reason why CFSs plays a vital role in international trade because this is the only place of contact for customs- related issues.
- These provide a safe area for Less than Container Load and Full Container Load cargoes, that are brought directly to these stations. After proper inspection and checking of the cargo, the Customs Bonded Trucks (CBT) are sealed by the customs officers and are sent to the ports for export.
- These are involved basically in the activities of custom clearance. CFSs are the first point of contact for all customs-related issues.
- They facilitate the transit of goods by rail/road to and from serving ports for exporting and importing goods and cargoes.
- They receive the imported cargoes from the seaports, checks and confirms the customs stamp on them. Then, it delivers the same to the destined location.
- They serve as a unit for maintenance and repair of the containers.

### 5.2.2 | BENEFITS OF CFS

As mentioned earlier as well, container freight stations are situated close to ports and major inland distribution centres for smooth flow of goods. CFS takes the onerous to efficiently, safely and securely move goods from the port to the ultimate destination. The benefits associated with CFS are as follows:

- CFSs act as a common point for all cargoes coming from long distances. CFSs are built in places where goods to be exported and imported can reach easily.
- CFSs provide services of containerised goods for international trade purposes.
- CFSs provide custom clearance facilities near to places of production of goods (goods produced for export) as well as consumption of goods (goods imported from another country.)
- CFSs assist in reducing the level of demurrage and pilferage of goods when handled by CFSs.

- CFSs facilitate in saving time of customs clearance of goods that reach the gateway port, as the clearance is already done by the operators of CFSs.
- CFSs issue bill of lading to the shipping lines and takes the full responsibility of the shipment of goods.
- CFSs act as checkpoints before finally sending out goods to be exported, there are reduced chances of the overall level of empty container movement.
- CFSs assist in reducing the inventory handling cost is reduced as they provide service for the temporary storage of cargoes and act as the temporary warehouse for the goods.

CFSs have helped in de-congestion at the ports, which has led to an increase in the overall inflow and outflow of trade across nations.

#### SELF ASSESSMENT QUESTIONS

1. Container Freight Stations are facilities where cargo containers or freight shipments are stacked, de-stacked, and handled between different modes of transport. (True/False)
2. Prior to making any sort of investment before setting up of the CFS or before submitting the application, the parties must obtain an in-principle approval by the \_\_\_\_\_ commissioner.

### 5.3 APPROVAL OF CFS – GUIDELINES AND IMPLEMENTATION

A CFS is termed as a common facility equipped with the permanent installation and which offers services such as storing imported or exported goods, to empty containers carried under customs control, warehousing and time being storage for further transit.

Below are the procedures/guidelines and the implementation for the approval of CFS:

- The applications and proposals for setting up container freight stations will be processed only after receiving clearance from the Inter-Ministerial Committee of the CFSs. This committee consists of members and officials from the Finance department, Railways Department, Civil Aviation Department and the Ministries of Commerce. Apart from this, if required, inputs from the State Government is also taken to provide clearance.
- Before submitting the proposal and the application to the Inter-Ministerial Committee (IMC), the applicants are required to receive a go-ahead from the Jurisdictional Commissioner. In order to receive this, the applicants are supposed to submit their application to the Jurisdictional Commissioner who scrutinises the application and examines its feasibility. Only after the Jurisdictional Commissioner is satisfied with the proposal and confirms that it adheres to the guidelines, are applications submitted to the IMC. The Jurisdictional Commissioner is supposed to send his approval within 30 days of the submission of proposal to him.
- There is an online process of submission of proposal or the application. The applicants are required to visit the URL: [www.imcdryports.commerce.gov.in](http://www.imcdryports.commerce.gov.in) in order to submit their applications.
- It is expected from the applicant that he is familiar with the rules, regulations and process of the customs and its requirements related to the security insurance,

## NOTES

bonding, etc., and also, the charges which are supposed to be paid at the time of application.

- Upon receiving the applications and proposals from the desired applicants, the IMC is supposed to provide its approval/disapproval within a period of 60 days and not more than that. If they approve the proposal, they are supposed to issue a No Objection Certificate (NOC) to the applicant.
- Along with the NOC, the applicants are also provided with a Letter of Intent(LOI) which clearly states that they are allowed to set-up their infrastructure at CFSs. The letter also gives them a stipulated period of time within which they are required to set up their infrastructure. Investments made on the infrastructure before receiving the LOI is under the risk of the developer. Any such investment needs an approval from the Jurisdictional Commissioner.
- After receiving the approval and the LOI, the applicants get a time period of one year in order to set up their infrastructure. In case there is a need for extension, it depends on the decision of the IMC who examines the progress of the set-up and accordingly grants an extension or withdraws the approval.
- The applicants are supposed to submit quarterly reports to the IMC providing details of the progress of the infrastructure. These reports are to be submitted as per the required proforma and guidelines.
- While setting up the infrastructure, the applicants should adhere to the regulatory requirements as per the Customs Act, 1992, because only then the set-up will become functional.
- In presence of the below-mentioned situations, the IMC has the right to revoke the approval:
  - If the applicants are found guilty in breaching of the contract, or
  - If the committee feels and is sure that the infrastructure is not in accordance to the public interest, or
  - If the CFS has offended any of the provision of the Act in force and is under conviction.

## SELF ASSESSMENT QUESTIONS

3. The applications and proposals for setting up container freight stations will be processed only after receiving clearance from the Inter-Ministerial Committee of the CFSs. (True/False)
4. While setting up the infrastructure, the applicants should adhere to the regulatory requirements as per the Customs Act, \_\_\_\_\_.

## 5.4 ROLE OF CONTAINER CORPORATION OF INDIA LIMITED IN LOGISTICS

Container Corporation of India Limited, commonly known as CONCOR, was incorporated as a public sector entity and was given autonomous rights under the Ministry of Railways in the year 1988. The basic agenda of constituting CONCOR

was to keep the multi-modal transport logistics organised. Its main focus is on facilitating the international trade of a country. CONCOR operates to make the export/import of containerised goods efficient and economical.

CONCOR is in sync with the activities of other agencies involved in warehousing, transportation by roads and rails, customs clearance activities, etc. CONCOR, upon receiving the containerised goods, issues waybill and works with the railways in the movement of goods by rail to the ports and vice versa.

CONCOR started functioning in March 1988 with a total capital of 165 crores, which included authorised capital of 100 crores and the remaining as the paid-up capital.

The role of CONCOR is characterised by three major activities, which are of a Carrier, a Terminal Operator and a Warehouse Operator. The three major activities are:

- **Carrier:** CONCOR is majorly involved in rail transportation as part of its transportation plan and strategy. Most of the terminals of CONCOR are linked to the rails, and rails are the main carrier of goods and cargoes in containers. However, first and last-mile transportation services are provided by road as well. The cost of transportation of goods by rails over long distances is competitive. This cost-benefit is transferred to the client which allows for flexible pricing. These rail linkages also help in bringing down the level of congestion at the ports and the road passages which are linked to these ports.

Although major involvement of CONCOR is on rail transport, there are some exclusive terminals where only road-led transportation services are provided. These are mainly the additional services of door-to-door delivery of goods. Also, in cases where the road is more economical, rail is not chosen as an option there.

- **Terminal and Warehouse Operator:** The inland container depots or the container freight stations are dry ports which are part of CONCOR. These dry ports provide all the services and facilities of the ports including the facility of custom clearance at the doorstep of the customers. These terminals are mostly linked by rails to the Indian Railways network unless and until the size of goods or the location demands the use of roads. The rail linkages help in the movement of a large volume of goods through long distances in a short span of time and in the most cost-effective way.

The terminals of CONCOR provide a number of essential facilities such as that of a warehouse, parking of containers, repairs of containers, etc. The logistics chain derives valued services from CONCOR such as:

- Warehousing facilities for in-transit goods in export and import.
- Facilities of bonded warehousing which enables the importers to store all the goods over a longer period of time, taking away cargoes in instalments which helps them in deferring the duty payments.
- Consolidation and reworking of Less than Container Load cargoes.
- Facility of clearing air cargo by the use of bonded trucking.

The door-to-door pickup and delivery systems are very common in domestic trade. CONCOR also helps single customers in moving cargo to multiple locations.

## NOTES

The major role played by CONCOR is that it provides a single platform where all the activities and facilities served by different parties involved in the movement of cargo containers are coordinated. In order to attain customisation of a top-notch degree, the most effective combination of rail and road transportation is provided. Such a combination is also cost-effective. CONCOR, hence, provides to its customers, tailor-made services which help customers in a way where their efforts are minimised.

### Container Booking Process Flow in Terminal and Warehouse

The booking procedure of cargo containers at CONCOR are as follows:

- The consigner has to register first by paying a sum of ₹ 1,200.00 as per his selected option for either door picking of containers by CONCOR or picking up at the terminal.
- Then, the empty containers are allotted depending upon the options of either door picking or terminal.
- The containers are finally loaded/stuffed at a warehouse/factory or at the terminal as per the option.
- The consignor then submits a forwarding note along with a copy of the invoice which contains all the details of the cargo.
- The consignor then is required to make a payment of the freight amount.
- Then, there is an invoice or inland waybill generated in favour of the consignor.
- The container is finally delivered to the destination upon submission of the I.W.B. or the invoice.

The official processes for containerisation in CONCOR are summarised in the process flow charts given below:

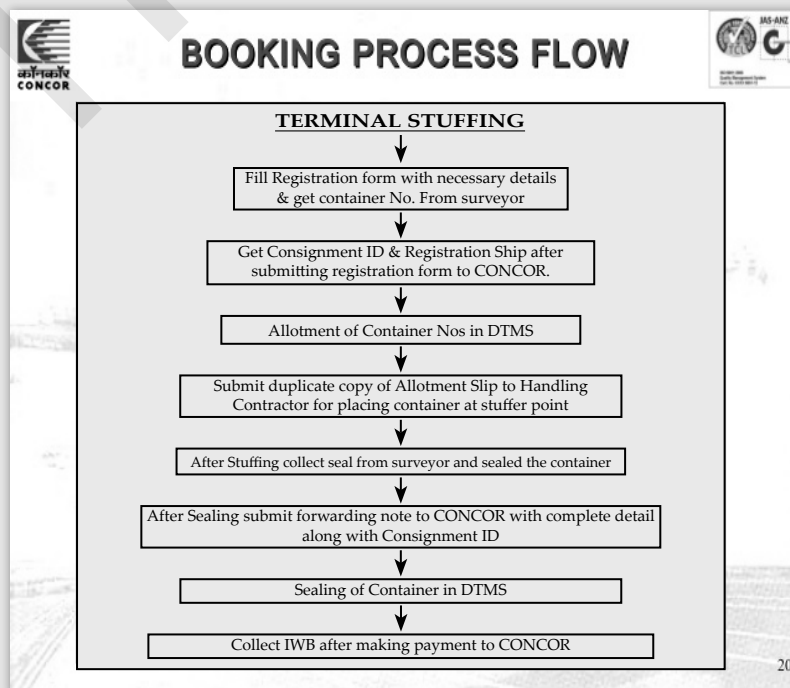

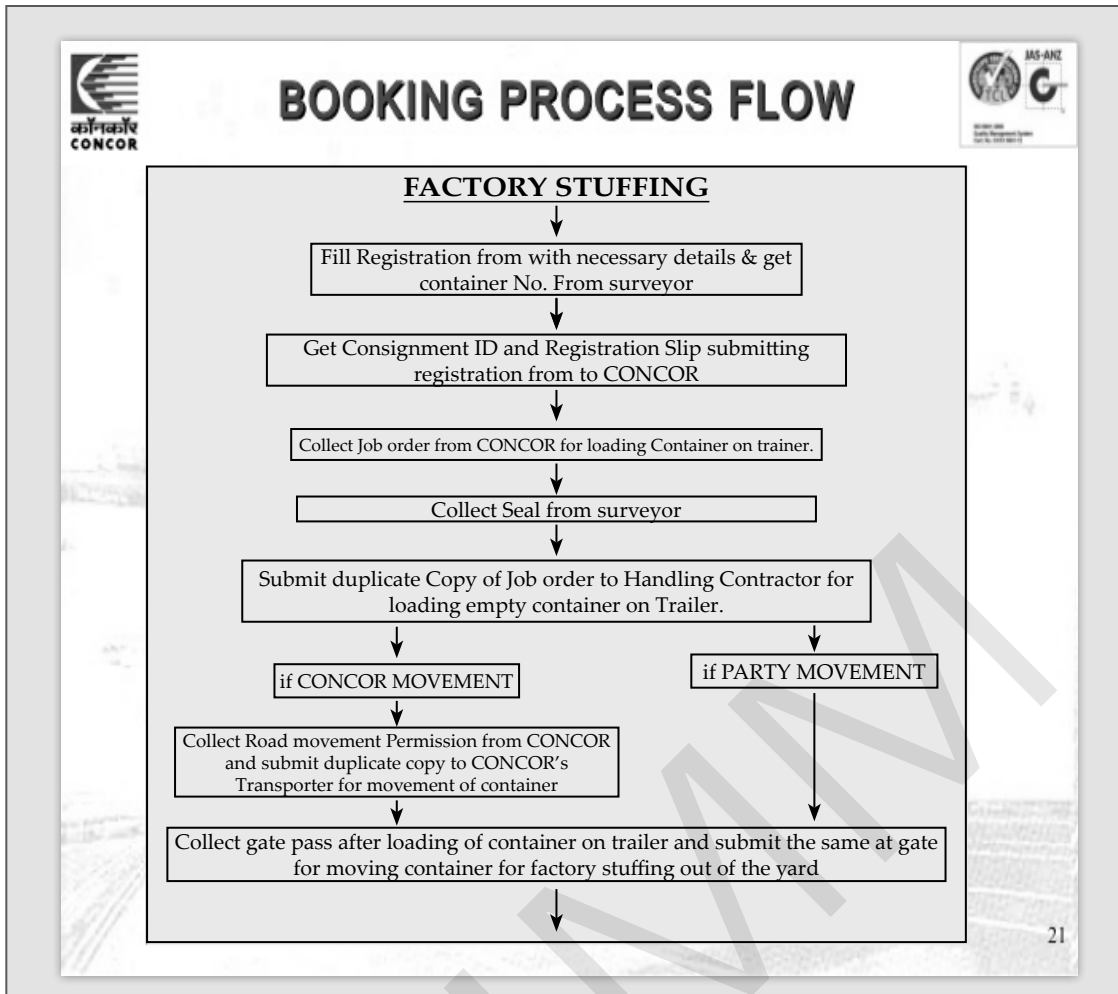

### 5.4.1 | FUNCTIONS OF CONCOR

Owing to the country's growing domestic and international business, the Government of India decided to set up an autonomous organisation to look after the logistics services and, thus, formed the Container Corporation of India Limited. CONCOR aims at providing efficient and reliable multi-modal logistics support for the country's domestic and international trade and commerce activities.

The core functions of CONCOR are as follows:

- It works for bringing about a container resolution in India.
- It is involved in building up and operating the infrastructures in order to organise the linkages of roads and railways so that imports of international containers increase in the country.
- It sets up and manages all the container freight stations and inland container depots of the country and acts as a guardian and custodian on behalf of the customs.
- It effectively works in sync with all the agencies which are working for the international trade and are involved in the transport of containerised goods and cargo in order to provide services for door-to-door transportation of goods. It, therefore, acts as a carrier of the goods carried in containers for international trade.

5. The role of CONCOR is characterised by three major activities which are of a Carrier, a Terminal Operator and a \_\_\_\_ Operator.
6. Container Corporation of India Limited was incorporated as a public sector entity which was given autonomous rights under the Ministry of Home Affairs in the year 1978. (True/False)
7. Match the following:

List A	List B
1. Inter-Ministerial Committee (IMC)	a. Provides facilities where cargo containers/freight shipments are stacked, de-stacked, and handled between different modes of transport.
2. No Objection Certificate (NOC)	b. Incorporated as a public sector entity, which was given autonomous rights under the Ministry of Railways in the year 1988.
3. Letter of Intent (LOI)	c. Document issued after the approval of the application of setting up of CFS.
4. CONCOR	d. The applications and proposals for setting up Container Freight Stations will be processed only after receiving clearance from the Inter-Ministerial Committee of the CFSs.
5. Container Freight Station	e. Document which clearly states that the applicants are allowed to set up their infrastructure at CFSs.

- a. 1-c, 2-d, 3-e, 4-b, 5-a      b. 1-a, 2-c, 3-e, 4-b, 5-d  
 c. 1-d, 2-c, 3-e, 4-b, 5-a      d. 1-c, 2-d, 3-a, 4-b, 5-a

## 5.5 SUMMARY

- Container freight stations or CFSs are facilities where cargo containers/freight shipments are stacked, de-stacked, and handled between different modes of transport.
- Container freight stations, commonly known as CFS, are nothing but centres of multi-modal logistics system wherein cargo containers and customs are handled.
- Container freight stations are directly connected to the seaports by way of roads or rails and are a point of transshipment for exports and imports of all sorts of goods.
- The officers who are appointed as guardians of the CFSs are required to monitor and provide custom clearance services for the export and import of goods and cargo.
- The pre-requisites of setting up of CFS are prior survey, in-principle approval by Jurisdictional Customs Commissioner, land requirements, design and layout and infrastructure.

- A survey prior to setting up of CFS must be done by an external facility so that the data and information retrieved regarding CFC set-up is accurate and true in all respects.
- The operations of CFS were privatised after the decision taken vide Circular No.128/95-Cus dated 14<sup>th</sup> December, 1995.
- The basic reason of bringing in the private sector was to enhance the development of the infrastructure at a place away from the gateway ports in order to avoid congestion at the seaports because of the widespread economic growth and industrialisation in the countries.
- The officers who are appointed as the guardians of the CFSs are required to monitor and provide custom clearance services for the export and import of goods and cargo.
- The role of CONCOR is characterised by three major activities which are of a carrier, a terminal operator and a warehouse operator.

## 5.6 KEY WORDS

- **CFSs (Container Freight Stations):** They act as centres of the multi-modal logistics system wherein cargo containers and customs are handled.
- **The Customs Act, 1962:** It is a law which serves as the approval of the container freight station.
- **Infrastructure:** It infers having strong connectivity of electronic data interface and a good communication system in order for the CFSs to work efficiently.
- **CONCOR:** It was incorporated as a public sector entity which was given autonomous rights under the Ministry of Railways in the year, 1988. The basic agenda of constituting CONCOR was to keep the multi-modal transport logistics organised. Its main focus is on facilitating the international trade of a country.
- **Jurisdictional commissioner:** He checks if the details and the information provided by private or public body abide by the set guidelines.

## 5.7 CASE STUDY: INFORMATION TECHNOLOGY EASING LOGISTICS OPERATION

### Abstract

In the recent trends, there is a substantial growth in consumerism and other factors such as entry of new and individual traders in the market which has curtailed an organisation's ability in choosing the right container freight station which is beneficial for them. Not only this, there are various challenges which have arisen in the direct port delivery of the goods and cargo. Keeping these things in mind, it is very important for container freight stations to differentiate and optimise their operations so that the volatile market conditions don't have an adverse effect. As per the recent studies, it has been stated that there is an increase in the demands of the customers and because of this it is very necessary for the CFSs to employ and equip itself with advanced technologies and sophisticated IT solutions, which will

bring about a positive change and an efficient control leading to profitability at the competitive horizon.

### Challenges

There is a client of Kale Logistics named Continental Warehousing Corporation (CWC). The major initiatives taken by Continental Warehousing Corporation were setting up of container freight stations/inland container depots and private freight terminals which were to be combined with other activities of import/export of goods and cargoes.

CWC was operating with multiple applications used for multiple operations at their individual CFS/ICD locations. The aim was to eliminate the use of all multiple applications which were running at its locations. Because of the use of such multiple applications, CWC was unable to efficiently plan and strategise its operation flow. The major challenges which CWC were facing were:

- Absence of consolidated data and information with reports showing the overall operations in the overall locations.
- Time-taking task of capturing data from all the locations of its operating CFS/ICD.
- Use of multiple applications led to an increase in the maintenance cost.
- Maintaining multiple vendors was a haywire activity as each individual was handling each application system.

### CAPELLA (Container Management Software) derives competency in operations

CWC on the recommendation of Kale Logistics decided to use CAPELLA (**Container Management Software**) because it was capable of handling functions of FCL/LCL more efficiently by its easy to use UI and strong n-tier design. None other platforms in the existing market had such capabilities. On the integration of CAPELLA with that of financial management applications, it was able to provide full-fledged solutions, by use of which, large CFS/ICD can be automated to perfectly fit the requirements of the client.

After CWC started using CAPELLA, it experienced a huge change in their operating systems and these changes were highly beneficial to them. CAPELLA was able to manage all the applications which were running at different locations, at a single place in a single system. Apart from this, CAPELLA was also able to address and resolve major issues related to managing the yard, container inventory, accurate invoicing, automatic emails which were sent to the stakeholders and information about the real-time status of the container.

With the use and the implementation of CAPELLA, CWC was able to meet all the requirements of its business efficiently just because CAPELLA provided feature-rich and integrated solutions. Apart from this, Kale Logistics also introduced MS Windows Azure, a cloud computing software in CWC to cater to cloud services for computing, analysing, storing and networking data. Through the use of MS Windows Azure platform, the time taken for the deployment of infrastructure reduced and the additional costs on the maintenance and administration was also eliminated. With

this success and positive feedbacks from the users, Kale Logistics was motivated to use this application and even suggested it for all future CFS/ICD locations.

## QUESTIONS

- How did CAPELLA help the client CWC?  
(**Hint:** CWC was able to manage all the applications which were running at different locations, at a single place in a single system.)
- What were the problems and challenges faced by CWC in the absence of CAPELLA?  
(**Hint:** Absence of a consolidated data and information, time-taking task of capturing data, increase in the maintenance cost, etc.)
- Why did CWC want to eliminate the use of all multiple applications being run at its various locations?  
(**Hint:** CWC was unable to efficiently plan and strategise its operation flow.)
- What were the major issues CAPELLA was able to solve?  
(**Hint:** Managing the yard, container inventory, accurate invoicing, automatic emails which were sent to the stakeholders and information about real-time status of the container.)
- Apart from CAPELLA, which other software helped CWC?  
(**Hint:** MS Windows Azure provided cloud services for computing, analysing, storing and networking data.)

## 5.8 EXERCISE

- What do you mean by container freight stations?
- Explain the concept of container freight stations.
- What are the pre-requisites of setting up container freight stations?
- Explain the functions of container freight stations.
- What are the functions of CONCOR?

## 5.9 ANSWERS FOR SELF ASSESSMENT QUESTIONS

Topic	Q. No.	Answer
Concept of Container Freight Stations	1.	True
	2.	jurisdictional customs
Approval of CFS – Guidelines and Implementation	3.	True
	4.	1992
Role of Container Corporation of India Limited in Logistics	5.	Warehouse
	6.	False
	7.	c. 1-d, 2-c, 3-e, 4-b, 5-a

## 5.10 SUGGESTED BOOKS AND E-REFERENCES

### SUGGESTED BOOKS

- Pandey, N., & Singh, N. (2016). *Containerisation, Logistics Management, and Foreign Trade*. New Delhi: Shipra Publications.
- Glass, D. (2013). *Freight Forwarding and Multi-Modal Transport Contracts*. Hoboken: Taylor and Francis.

### E-REFERENCES

- Govindarajan, M. (2019). Container Freight Stations. Retrieved 3 October 2019, from [https://www.taxmanagementindia.com/visitor/detail\\_article.asp?ArticleID=8405](https://www.taxmanagementindia.com/visitor/detail_article.asp?ArticleID=8405)
- Container Corporation of India Ltd: Core Business. (2019). Retrieved 3 October 2019, from <http://www.concorindia.com/corebusiness.asp>

# Dry Ports in Logistics Management

## Table of Contents

---

- 6.1 Introduction
- 6.2 Concept of Dry Port
  - 6.2.1 Importance of Dry Port
  - 6.2.2 Types of Dry Ports
    - Self Assessment Questions
- 6.3 Major Services Provided in Dry Ports
  - Self Assessment Questions
- 6.4 Future Prospects for Dry Ports
  - Self Assessment Questions
- 6.5 Summary
- 6.6 Key Words
- 6.7 Case Study
- 6.8 Exercise
- 6.9 Answers for Self Assessment Questions
- 6.10 Suggested Books and e-References

**LEARNING OBJECTIVES**

*After studying this chapter, you will be able to:*

- Discuss the concept of dry port
- Explain the importance of dry port
- Describe the types of dry ports
- Explain the major services provided in dry ports
- Discuss the future prospects for dry ports

**6.1 INTRODUCTION**

In the previous chapter, you studied the concept of freight stations, its functions and benefits. The chapter elucidated on approval of Container Freight Station (CFS) along with guidelines and implementation. Finally, the chapter described the role of Container Corporation of India Ltd. in logistics.

In today's highly competitive and dynamic marketplace, the organisations are under pressure to find new ways to create value to be delivered to customers at the right time and at the right place. Organisations have realised the need for effective logistics management in such a competitive environment. The efficient supply chain needs to be requisite for the organisations that can help them in achieving their goal by enhancing the level of services in a cost-efficient manner. An important factor for a successful logistics management system is to have a coordinated approach and emphasise on effective communication with the suppliers and customers. An integration of activities, cooperation, communication throughout the organisation and supply chain are required to manage the logistics activities within the supply chain. Advanced and updated information and communication technologies enable organisations to deal with the issues that can arise due to the changes in the logistics functions. Nowadays, the demands of the customers are growing. Hence, the organisations use their integrated systems for fulfilling the customers' demand. In this manner, the requirements of the customers are met through a continuous process.

According to the **Council of Logistics Management**, *Logistics is part of the supply chain process that plans, implements, and controls the efficient, effective flow and storage of goods, services, and related information from the point of origin to the point of consumption in order to meet customers' requirements.*

The organisations look forward to moving their goods through an integrated transport solution which are safe and cost-effective. The combination of inland freight distribution system, intermodal logistics and distribution networks gives the organisations a competitive advantage.

Inland distribution systems include dry ports which exist within the seaport system. Dry ports have become important in formulating competitive strategies. With a dependence on the seaport, shipping has created the need for inland terminals, and, hence, the dry ports become the necessary aspect in supply chains. Dry ports help in providing valuable space for a number of value-adding logistics services

of containers and bulk cargoes that enter or leave. Cargo enters dry port through different modes of transport.

In this chapter, you will study the concept of dry port and its importance. Next, the chapter describes the types of dry port. Further, the chapter explains the major services provided in the dry ports. At last, the chapter highlights the future prospects for the dry ports.

## 6.2 CONCEPT OF DRY PORT

Dry ports are terminals that are situated near the seaport. They are well connected to the seaport through road and rail. Also, the dry ports are directly connected to the seaport and they work with inland intermodal terminals.

Dry ports are based as a centre for the transshipment of sea cargo where people leave their goods at intermodal loading units for forwarding to various inland destinations. They also include facilities for storage and shipping goods for connecting further to the road or rail cargo carriers and also for services of customs clearance. The dry ports are also called inland ports or multimodal logistics centres which help reduce the congestion of space and storage at the seaport itself. There are various facilities of cargo handling, warehouses, container yards, railway sidings and a number of other services in regards to import and export clearances. The dry port's performance can be determined by the proximity to the road and rail interface. Therefore, it is important to have high-capacity transportation to and from the seaport. The transport needs to be reliable and scheduled effectively for the system to run smoothly.

According to **Roso, Woxenius and Lumsden**, *a dry port is an inland intermodal terminal directly connected to a seaport, with high-capacity traffic modes, preferably rail, where customers can leave and/or collect their goods in intermodal loading units, as if directly to the seaport.*

The dry ports are named inland ports as they are similar to the seaports in regards to their services and are normally found in the interior from the coast. Moreover, at the same time, it does not keep cities away from sea access. The fast-rising flow of containers has resulted in the terminals getting crowded, which result in a lot of congestion and long waiting times for the containers. Therefore, the need for easing congestions from the main ports is to change the path where the large trans-ocean vessels move to few ports at each continent. The feeder vessels and connect to many smaller ports. Due to developments in technology and the economy, the individual main ports try to attract as much flows as possible. The dry ports entail the following features:

- They act as an intermodal terminal
- They are situated inland
- They have an effective rail connection to a seaport
- They offer a variety of value-added services that are available at seaports
- They help carry out important functions of a port, such as storage, consolidation and distribution of the goods
- They provide customs clearance

## NOTES

The dry ports can be divided into the following:

- Close dry port
- Midrange dry port
- Distant dry port

### 6.2.1 | IMPORTANCE OF DRY PORT

The dry ports are important as they provide better access to goods and services. The modal shift from road to rail results in reducing the congestion at the seaports and other areas. The dry ports offer high-end services in the hinterland at low cost along with improving access to the seaports. Hinterland refers to the areas of the country that are away from the coast or river body and it serves as a place for imports and for exports.

The dry ports help in the movement of containers from road to rail which benefits the rail operators since it helps in increasing their level of business. A well planned and running dry port offers a larger range of logistics services in the dry port area with the option of using rail rather than the road, which indirectly helps in reducing the environmental impact on the products.

The dry ports are beneficial in moving operations into the hinterland and into further inland areas that are away from the water resources. This way the ports are able to handle and send the freight from their terminals faster which helps make space for the new incoming cargo.

The transport terminal helps to bring down transportation by roads and reduce the harmful pollution effect on the environment. Dry ports act as a buffer for taking care of the congestion and stocking area of the seaports. The seaports are able to manage the problem of the lack of space or improper inland access by having a dry port near the seaport. This, in turn, helps the seaports in increasing their terminal capacity. This increase in terminal capacity results in more productivity with larger container ships coming to the seaport. The dry ports have benefited the environment by bringing down the level of pollution and carbon dioxide emissions while taking care of the congestion at the terminals. The movement of the containers from road to rail reduce the congestion on the roads and the seaport terminals. The various operations and services at the dry port help in adding value to the services and capabilities that take place. Some of the services and capabilities are as follows:

- To handle and provide third- and fourth-party logistics
- To introduce new tailored services
- To enable in handling heavy types of cargo
- To adapt the changing schedules
- To assist in making fast decisions on the schedules and changing orders
- To provide various kinds of services in intermodal operations
- To send cargo through the multiple routes and modes at a short time

- To act as a collaborative intermodal hub for the networks
- To possess the capability of delivering tailored services to different market segments

According to **Vandervoort and Morgan**, a dry port must fit into a complex system where the necessary supporting infrastructure (roads, railways) is in place, maintenance is assured, and the legislative, regulatory, and institutional systems are properly designed to optimise the involvement of both the public and the private sector.

The benefits of having dry ports are as follows:

- They help in the reduction of transportation cost of moving freight inland by rail rather than road
- They result in reduced transport costs which reflect in lower prices for traded goods
- They boost trading and growth due to the lower prices for traded goods
- They strengthen multimodal solutions along with reducing the cost
- They further boost investments from other economic activities
- They help to cut down on transport cost of moving freight inland by rail rather than road
- They enhance supply chain with a better system of transport into the processes
- They improve access to seaports with cheaper logistics
- They provide access to services of customs clearance and other additional logistic services

### 6.2.2 | TYPES OF DRY PORTS

The geographical location of dry ports has a significant impact on the future performance, since they are an intermodal terminal, having rail connection with the port. These days the organisations are more focussed on the external costs of different transport means and their effect on the environment. They normally tend to use dry ports which are located closest to their productions site for the location of the intermodal terminal. The location of a dry port depends on the concentration of areas of the receiver of goods or the shippers and the requirements of the port. The distance of the rail connection between the dry port and the port can be determined according to the various aspects of the allocation of the intermodal terminal.

An effective and totally functional dry port helps to increase the operational efficiency promote safe environmental practices. Dry ports help relieve road congestion of port cities. The dry ports also help in removing the congestion from the seaport by vacating important space from these water terminals. Normally, it is the various forms of custom, clearance and other forms of information handling which takes up a lot of space and adds to the congestion. Apart from this, there are other activities such as emptying the containers, stuffing and stripping which can be done at the dry port, which further helps in saving the valuable space in the port.

## NOTES

Dry ports are also known as inland ports or inland intermodal terminals. They act as trans-shipment point which is connected to the seaport by rail or road for the transportation of goods.

There are three different kinds of dry ports:

- Close dry port
- Midrange dry port
- Distant dry port

Let us discuss these in detail.

- **Close dry port:** Close dry ports are located near the actual seaport and they integrate the road transport to and from shippers outside the city. The close dry port areas have a rail shuttle service to the port which helps relieve the city streets and the port gates. The normal distance between the dry port and the seaport is not more than 100 kilometres.

Close dry ports offer seaports increased terminal capacity and also a place for the depot. The close dry port offers buffering containers and loading them on the rail shuttle along with integrating for road transport to and from the seaport. This is done in synchronisation with the loading of a ship in the port. This effectively needs a rail service which is reliable.

A representation of a close dry port is shown in Figure 1:

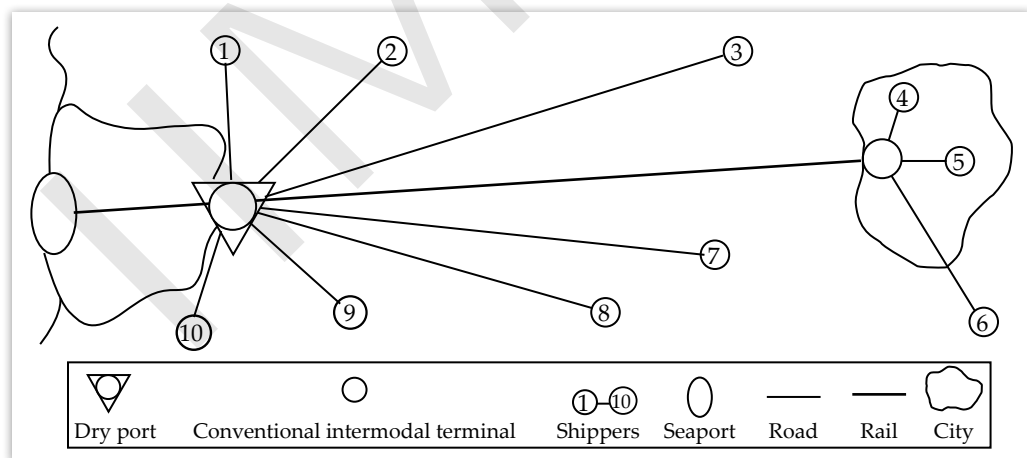

FIGURE 1: Close Dry Port

Source: [www.sciencedirect.com/science/article/abs/pii/S0966692308001245](http://www.sciencedirect.com/science/article/abs/pii/S0966692308001245)

- **Midrange dry port:** Midrange dry ports are normally situated at a distance of approximately 200-500 kilometres from seaport. Midrange dry ports serve as a consolidation point for different rail services and they usually offer depot facility. The high frequency which is determined by combining flows together along with effectively covering short distances initiates the loading of containers in the dedicated rails. These midrange dry ports serve as the substitute in reducing the stacking areas at the seaport.

A pictorial representation of a midrange dry port is shown in Figure 2:

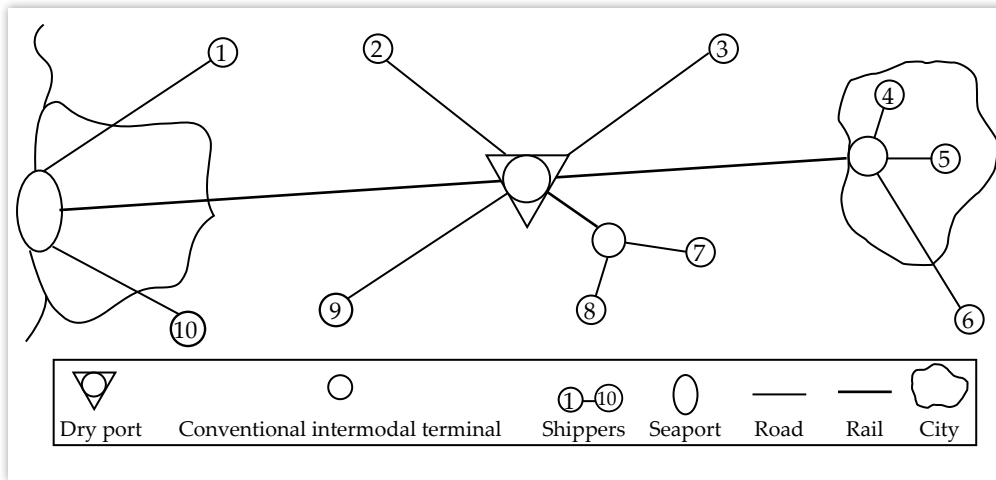

FIGURE 2: Midrange Dry Port

Source: <https://www.sciencedirect.com/science/article/abs/pii/S0966692308001245>

- **Distant dry port:** The distant dry ports are the most standardised dry ports and are located more than 500 kilometres from the seaport. The main advantage of the distant dry ports is that they are cost-effective in providing important transportation over long distances through rail transport or barges. Since they are used for long distances so rail transportation mode becomes more cost-efficient than road transport. Due to the modal shifting from road transport to rail transport it proves to be beneficial. Distant dry ports lead to lesser congestion and are less harmful to the environment. The distant dry ports are beneficial for the rail operators because they increase the limit of doing business. Distant dry ports help improve the seaport requirements by offering a more efficient inland access for transportation and loading of goods.

A pictorial representation of distant dry port is shown in Figure 3:

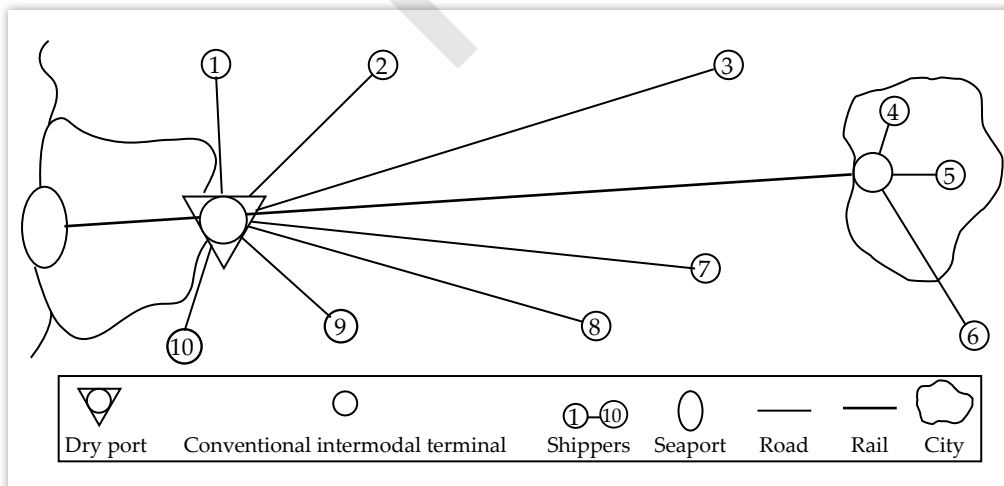

FIGURE 3: Distant Dry Port

Source: <https://www.sciencedirect.com/science/article/abs/pii/S0966692308001245>

1. The location of a \_\_\_\_\_ depends on the concentration of areas of the receiver of goods or the shippers and the requirements of the port.
2. Dry ports do not act as a buffer for taking care of the congestion and stocking points of the seaports. (True/False)

### 6.3 MAJOR SERVICES PROVIDED IN DRY PORTS

The main issue which is faced by the seaports is the increase in the containerised transport. There is a lack of space at the terminals of the seaport and the increase in the congestion on various routes serving the terminals. The dry ports are intermodal terminals in the seaports' hinterland which directly connects to the seaport. Dry ports are connected through various modes, such as the rail and roads. The dry ports supply all logistic facilities and have large containers which are needed for shipping and forwarding agents in a port. Dry ports are able to handle various forms of cargo and heavy goods. They have the facility of depot, transshipment, maintaining of the containers and storage units. The value-added services at the dry ports help the customers with convenience, saving time and lesser operational costs.

The dry ports provide the same kind of facilities for the importers and exporters which are normally available at the seaports.

Various procedures related to customs and duties are carried out along with storage and inspection of containers in the dry port. The logistics service costs get saved when the customs clearance is completed at the premises or warehouse of the exporter. These savings eventually help lower the production cost which benefits the customers and makes it more competitive in the international markets. The dry ports have the following objective:

- To provide extra hinterland space for the port
- To have a terminal where the port is able to outsource its functions and have the same facilities as found in the seaport
- To improve the efficiency and effectiveness of the logistics chain with a high-quality terminal
- To connect directly with seaports through rail or road
- To provide effective modal shift with high capacity traffic mode, which is normally through rail

The dry ports have a major advantage that the custom expenses of imports and exports can be managed throughout the year in an even manner. They do not need to be cleared at one go or in a bulk and can be evenly spread within the year which helps give a better advantage, along with the improved facility of container freight station which has all the required facilities that are needed in a port.

Various kinds of value-adding services that a dry port provides highlight the importance of the dry ports which is integrated into the supply chain and takes care

of the transactions between different areas and countries. Dry ports help provide sea access to the landlocked countries and play an important role in enhancing the trading facilities between the countries. The facilities that are available at the dry ports are:

- Large and bulk container yards
- All kinds of transit sheds
- Various types of warehouses
- Railway siding
- Truck parking

The dry ports are totally equipped with the latest cargo-handling equipment with other functions of loading and unloading of containers. These functions are mechanical processes which do not require extra labour along with other facilities of all statutory clearances relating to the export and import, and transportation of the cargo at the dry port facilities.

Various other services that form part of dry ports are as follows:

- **Container yards:** Container yards refer to a facility from which ocean carriers receive and deliver ocean containers. Container yards provide a facility where cargo containers are moved between various modes of vehicular transport for further transportation; for example, moving containers from ships to trucks. They undertake the following:
  - Container handling for large and bulk cargoes
  - Storage facilities
  - Intermodal transfer-bonded cargo
- **Container freight stations:** They act as centres of the multimodal logistics system wherein cargo containers and customs are being handled. These stations also help organisations in handling and storing their export or import goods as well as the empty containers on a temporary basis. They provide the following services:
  - Loading and unloading of international and domestic standardisation (ISO) and non-ISO containers
  - Short-term storage of cargo (bonded and unbonded)
  - Limited freight forwarding
  - Consolidation of cargo and banking services
- **Inland container depot:** They provide all the services and facilities of the ports including the facility of custom clearance at the doorstep of the customers. They provide the following:
  - Container handling and storage
  - Container loading, unloading, sorting and un-sorting

## NOTES

- Storage and handling of break-bulk cargo
  - Container light repairs
  - Cargo consolidation services and freight-forwarding facilities
  - Banking, insurance and financial services
- **Logistics park or freight depot:** Logistics park or freight depot refers to an area where cargo is parked while it awaits for onward transportation. It undertakes the following:
- Handling and storage of containers
  - Loading and unloading of containers, with sorting and un-sorting
  - Cargo handling and storage of break-bulk cargo
  - Customs inspection and clearance
  - Repairs of light container
  - Cargo consolidation services and freight forwarding
  - Financial, banking and insurance services
  - Value-added warehousing
  - Management of inventory
  - Material packaging and handling services

## SELF ASSESSMENT QUESTIONS

3. The dry ports are intermodal terminals in the seaports of \_\_\_\_\_ which directly connects to the seaport.
4. Dry ports help provide sea access to the landlocked countries and eventually play an important role in enhancing the trading facilities between the countries. (True/False)

## 6.4 FUTURE PROSPECTS FOR DRY PORTS

The implementation of dry ports can be very beneficial and improves the logistics and supply chain efficiency and effectiveness. The dry ports with the right infrastructure, high capacity, modern equipment area take advantage since they provide adequate storage capacity and create benefits for the end users and the shippers. It is necessary to keep the technological and economical aspects in mind while deciding on a suitable location which helps evaluate the costs and competitiveness of intermodal transport.

Globally, the tri-modal and bimodal terminals have become an important part of the transport system. This is more so in places that are the gateway regions that have a high dependency on trading. The transport system is slowly shifting inland with the focused development of maritime shipping networks and various other port terminals. With the increase in the co-modal and intermodal transport solutions, the logistics for the hinterland has moved into the various modes of the modern freight

distribution system. Initially, transportation by roads and trucks were enough during the initial phase of the development of inland freight distribution systems. But over a period of time, it led to congestion, consumption of energy and many other reasons which led to further expansion of the transport system. These reasons were enough for considering the setting of inland terminals during the next step in the regional freight planning.

The emerging functional relationship of the port terminals with hinterland has resulted in the development of dry ports around the world. On the international front, China has initiated this development since its objective is to promote trade and economic activities through central Asia, all the way to Europe.

Each dry port is different from the other and has its own geographical, economical, regional and other regulatory settings. Such factors ultimately determine the functions of the dry port, in relation to the seaports.

In India, the government has decided to take care of problems faced by the exporters and importers because of infrastructural constraints. Therefore, government takes care of the 300 plus dry ports in the country for initiating the increase of foreign trade in India.

The government has started the work of analysing the laws that govern the dry ports, their subsidies and understand their funding patterns. It is done to streamline Indian ports according to the global practices.

This move should help to increase the foreign trading, where the government is accessing the transaction costs involved in trading, and hence it aims to have new dry ports in the country based to strengthen logistics. The government of India plans to bring in the benchmarks for identifying the framework of international best practices for Indian operational standards to conform with international ports. Dry ports help to improve the logistics in the supply chain along with bringing down the capacity constraints that are faced by the seaports and analyse the factors of loading, unloading and the turnaround time. The important dry ports are being built in India. The CFS at Mundra in Mumbai and another one at Katuppali in Chennai are the dry ports for helping with the container traffic at the other ports.

**SELF ASSESSMENT QUESTIONS**

5. The government of India plans to bring in the \_\_\_\_\_ for identifying the framework of international best practices with the Indian operational standards.
6. The CFS at Mundra in Mumbai and another one at Katuppali in Chennai are the dry ports for helping with the container traffic at the other ports. (True/False)
7. Match the following:

List 1	List 2
1. Intermodal terminal	a. a dry port is less than 100 kilometres

## NOTES

List 1	List 2
2. Dry ports	b. seaport is approximately 200-500 kilometres
3. Close dry port	c. transport of freight using different modes of transport
4. Midrange dry port	d. an area away from the coast or river
5. Hinterland	e. an integral aspect of the supply chain

a. 1-e, 2-c, 3-a, 4-b, 5-d

b. 1-c, 2-e, 3-a, 4-b, 5-d

c. 1-b, 2-e, 3-d, 4-a, 5-c

d. 1-e, 2-a, 3-c, 4-b, 5-d

## 6.5 SUMMARY

- In today's highly competitive and dynamic marketplace, the organisations are under pressure to find new ways to create value to be delivered to customers at the right time and at the right place.
- The organisations look forward to moving their goods through an integrated transport solution which are safe, efficient and cost-effective.
- Dry ports are an integral aspect of the supply chain which has extended seaport activities inland. They are also an important part of logistics.
- Dry ports are an inland terminal situated near the sea and directly connected by road or rail to a seaport.
- The dry ports are similar to the seaports in regards to their services and these are normally found interior from the coast.
- Globally, the tri-modal and bimodal terminals have become an important part of the transport system.
- On the international front, China has initiated this development since its objective is to promote trade and economic activities through central Asia all the way to Europe.
- The implementation of a transport terminal helps bring down transportation by roads and its pollution effect on the environment.
- The geographical location of a dry port makes a significant impact on its future performance, since it is an intermodal terminal, having rail connection with the port.
- An effective and totally functional dry port helps increase the vitality and efficiency along with taking care of the environmental conditions.

- The main issue which is faced by seaports is the increase in the containerised transport, lack of space at the terminals of the seaport and increase in the congestion on various routes serving the terminals.
- The dry ports provide the same kind of facilities for the importers and exporters, which are normally available at the seaports.
- The dry ports have a major advantage that the customs expenses of imports and exports can be spread throughout the year in an even manner and can be released in a week or maybe even on a regular basis.
- The implementation of dry ports can be very beneficial and improve the logistics and supply chain efficiency and effectiveness.
- Each dry port is different from the other and they have their own geographical, economical, regional and other regulatory settings.
- In India, the government has decided to take care of problems faced by the exporters and importers due to infrastructural constraints.

## 6.6 KEY WORDS

- **Dry ports:** They are terminals which are found inland and are situated near the sea. They are well connected to the seaport through road and rail.
- **Hinterland:** It refers to the areas of the country that are away from the sea or river body.
- **Intermodal terminals:** It infers the transport of freight in containers using different modes of transport.
- **Midrange dry ports:** They serve as a consolidation point for different rail services and they usually offer depot facility.
- **Distance dry ports:** They are cost-effective in providing important transportation over long distances through rail transport or barges.
- **Container yards:** They are terminals where containers and cargoes are kept before and after being sent.

## 6.7 CASE STUDY: VIRGINIA INLAND PORT-IMPROVES CARGO SERVICE

The Port of Virginia is the second-largest volume port in terms of general cargo on the east coast in the United States. Established in 1952, the Port of Virginia is owned by the state which has the ability to handle more than 2 million TEUs (Twenty-Foot Equivalent Units). There were three traffic modes of seaport inland access where 25% of the cargo was moved by rail, 60% of the cargo was moved by trucks and around 15% of the cargo was sent by the barge (a long flat-bottomed boat). In 1984, the state decided to expand into new domains to cater to the Ohio Valley area as well through an inland port. An inland port acts as an extension of the seaport that existed for handling cargo in the same manner. Also, inland port was important to find a proper location for the site.

## NOTES

Keeping in view the potential market and connectivity, a new site was eventually selected subsequent to extensive R&D, feasibility studies and market analysis. To make sure that the terminal did not hamper the landscape and for adjusting the terminal with the surrounding area the site was well dug and ploughed so that the terminal could not be seen from the road. In 1989, Virginia inland port started its operations with an on-site rail.

There is a competent rail service that operates six times a week between the seaport and the facility. Monday and Tuesday were the very busy days with the transit time of 12 hours. Virginia inland port is at a distance of 350 km from the seaport and the process at the terminal of the seaport was very swift in shifting of the cargo from the vessel by straddle carrier to rail crane and thereafter to the rail. Earlier the Detroit train was used to carry 9,000 TEUs a year in the beginning from the seaport to the other destinations. Thereafter another train was introduced due to the increase in volumes and the advent of new customers. By the year 2006, the Virginia inland port was able to handle around 35,000 TEUs though it was capable of handling around more than 1,00,000 TEUs.

The customs services for customers at the Virginia inland port had all the levels of facilities that are needed as an important port for customs in the United States.

Though there is only 5% of TEUs which is done in terms of a physical inspection of containers at the seaport, customs clearance is very fast since they get information about the containers 24 hours prior to the unloading of the ship, and so the preliminary tasks are done earlier. The customs normally have 10 days in hand for the customs clearance even with the clearance being handled in 24 hours.

Due to the competition from the neighbouring ports the Virginia inland port wanted to invest in the development of inland terminals. The expansion of inland into new markets initiates faster movement of the containers from the port to their final destinations. It, further, increases the capacity of the port along with bringing in a competitive advantage for the port.

*Source: [https://www.unescap.org/sites/default/files/bulletin78\\_Article-5.pdf](https://www.unescap.org/sites/default/files/bulletin78_Article-5.pdf)*

## QUESTIONS

1. Why did the port of Virginia expand its operations?  
(**Hint:** To cater to new areas and new customers and serve as an extension of a seaport)
2. When did the Virginia inland port come into existence and how did it adjust with the environmental landscaping?  
(**Hint:** It did not hamper the landscape, potential market and connectivity.)
3. How did the productivity levels increase at the Virginia inland port?  
(**Hint:** Competent rail service, faster movement of cargo.)

4. What were the facilities available at the Virginia inland port terminals?  
(**Hint:** Seamless transport, transshipment points, etc.)
5. What were the competitive advantages gained by the Virginia inland port?  
(**Hint:** Instant customs clearance, faster movement of cargo, etc.)

## 6.8 EXERCISE

1. What are dry ports and why they are necessary?
2. Explain the importance of dry ports.
3. What are the different types of dry ports?
4. Explain the important services provided at the dry ports
5. What are the future prospects for the dry ports?

## 6.9 ANSWERS FOR SELF ASSESSMENT QUESTIONS

Topic	Q. No.	Answer
Concept of Dry Port	1.	dry port
	2.	False
Major Services Provided in Dry Ports	3.	hinterland
	4.	True
Future Prospects For Dry Ports	5.	benchmarks
	6.	True
	7.	b. 1-c, 2-e, 3-a, 4-b, 5-d

## 6.10 SUGGESTED BOOKS AND E-REFERENCES

### SUGGESTED BOOKS

- Arnold, P., Peeters, D. and Thomas, I. (2004), *Modelling a Rail/Road Intermodal Transportation System*, Transportation Research Part E, 40:255-270.
- Arnold, P., Peeters, D. and Thomas, I. (2004), *Modelling a Rail/Road Intermodal Transportation System*, Transportation Research Part E, 40:255-270.
- Arnold, P., Peeters, D. and Thomas, I. (2004), *Modelling a Rail/Road Intermodal Transportation System*, Transportation Research Part E, 40:255-270.
- Bergqvist, R., Wilmsmeier, G., & Cullinane, K. (2013). *Dry Ports, a Global Perspective*. Farnham: Ashgate.
- Cullinane, K. (2012). *Special Issue: The Dry Port Concept*. Basingstoke: Macmillan.

NOTES

**E-REFERENCES**

- (2019). Retrieved 5 October 2019, from [http://archive.northsearegion.eu/files/repository/20130301142236\\_WPC-TheDryPortConcept.pdf](http://archive.northsearegion.eu/files/repository/20130301142236_WPC-TheDryPortConcept.pdf)
- What is Dry port? Definition and meaning. (2019). Retrieved 5 October 2019, from <https://www.globalnegotiator.com/international-trade/dictionary/dry-port/>

WILMAM

# Introduction to Warehousing

## Table of Contents

---

- 7.1 Introduction
- 7.2 Concept of a Warehouse
  - 7.2.1 Nature and Importance of a Warehouse
  - 7.2.2 Types of Warehouses
    - Self Assessment Questions
- 7.3 Types of Warehouse Operations
  - Self Assessment Questions
- 7.4 Warehouse Location
  - Self Assessment Questions
- 7.5 Growth of e-Fulfilment and its Effect on Warehousing
  - Self Assessment Questions
- 7.6 Summary
- 7.7 Key Words
- 7.8 Case Study
- 7.9 Exercise
- 7.10 Answers for Self Assessment Questions
- 7.11 Suggested Books and e-References

**LEARNING OBJECTIVES**

*After studying this chapter, you will be able to:*

- Discuss the concept and nature of a warehouse
- Explain the meaning of warehousing
- Describe the importance of a warehouse
- Classify the different types of warehouses
- Elaborate on the growth of e-fulfilment

**7.1 INTRODUCTION**

We all need different types of products in our homes on the basis of our daily requirements. Sometimes we may buy these items in bulk as per our storing capacity and store them in our homes. For example, there are some grocery items, like flour, rice, etc., that we buy in bulk and then store them in our kitchens.

Likewise, a business also requires raw material, work-in-progress and finished goods to ensure the smooth running of its operations throughout the year. However, sometimes these items may not be available due to their scarcity or limited production in a particular time period, and here comes the role of warehousing. Take the example of a textile mill. It requires cotton balls or raw cotton for the production of clothes. As the production of textiles takes place throughout the year and there is a need for the continuous supply of raw cotton. Here, there is the need for storage of raw cotton subsequently to ensure smooth production without having any stock-out and breakdown. Warehousing does not end just with the storage of raw material, i.e., cotton, because after the production of textiles, it requires sales or distribution, and, thus, it needs storage of produced items for a certain period of time. A warehouse is any place, premise or a building where items, materials or products are stored.

In this chapter, you will study the concept of warehouse management. The chapter also describes the nature and importance of the warehouse. Moreover, you will also study various types of warehouses and their operations. At last, the chapter sheds light on warehouse locations, growth of e-fulfilment and its effects on warehousing.

**7.2 CONCEPT OF A WAREHOUSE**

Warehousing and inventory storage are not a modern concept. Warehouses have been existing since the early days of the Indus Valley Civilisation and Harappa. For instance, a warehouse that served Naval Trade was found in 'Lothal' (now in Gujarat) in around 2600 BC. Then, in the 18th and 19th centuries during the Industrial Revolution in Europe, warehouses started evolving and took a more specialised role in the industry. During this period, warehouses became more approachable and efficient in terms of product movement.

**According to Robert Hughes,** *warehousing is a set of activities that are involved in receiving and storing goods and preparing them for reshipment.* It is deemed that warehousing not only serves as a storage facility, but as a hub for various other activities, such as receiving, identifying, holding and assembling inventory and ensuring its availability

to meet the demand. Thus, a warehouse acts as an integral part of logistics that stores products between the point of origin and the point of consumption.

Warehousing involves getting products ready for reshipment with an ultimate objective to maintain the uninterrupted flow of goods. Readily availability of goods will ensure a higher degree of customer service and will further lead to customer satisfaction.

Procuring raw materials is an integral part of any manufacturing organisation. Raw materials are required to ensure a smooth level of production. However, before raw materials are used for producing finished goods, they require safety and good care to prevent any theft or damage. Thus, it is important for an organisation to have an effective warehouse in place and sound materials management practices.

A warehouse plays an important role in the supply chain of an organisation by holding or storing goods. There is a need to store a product before it is being shipped to customers as all products produced cannot be quickly delivered to customers; for example, in the case of motorcycle manufacturing, it is not possible to deliver the final products to customers immediately after production as customers are spread across different states or regions. Warehousing provides time and place utility for raw material, work-in-progress and finished goods. These days, organisations manage their warehouses in such a manner that they facilitate improved lead times, reduced logistics costs and increased competitive advantage. A well-managed warehouse facilitates an organisation to use customer service as a competitive tool. For instance, customers are kept up to date regarding their order status.

Warehouse Management System (WMS) is one of the most important concepts in modern warehousing. WMS is basically software that is used to track and manage warehouse activities. It is generally built in relation to Enterprise Resource Planning (ERP system) or industrial-strength relational database. It tracks and maintains all information related to the arrival and shipping of products in the warehouse. The core of WMS is a database of stock-keeping units and locator system. By this, it is easy to manage both the stock-keeping units and the storage locations. WMS facilitates in performing the following activities:

- **Receiving and shipping:** WMS is able to record the inflow and outflow of inventory. It helps record all the essential financial transactions, generate bills for payment for upstream suppliers, and send invoices to downstream consignees.
- **Stock locator system:** WMS also tracks storage locations of all individual products stored in a warehouse. It helps manage and track empty locations in the warehouse to ensure efficient utilisation of both space and labour hours.

Generally, features of WMS are divided into three broad categories, i.e., basic features, high-end features and advanced features as shown in Table 1:

TABLE 1: Various Features of Warehouse Management System

Basic Features	High-end Features	Advanced Features
Appointment schedule	Radio Frequency (RF) directed operation	Multi-Distribution Center (DC) view
receiving	Cycle counting	Stock keeping unit slotting

## NOTES

Basic Features	High-end Features	Advanced Features
Quality assurance	Cartoon manifesting	Broken case flow
Put-away	Replenishment	Electronic Data Interchange (EDI) capacity
Location tracking	Value-added services	Parcel shipping
Work order management	Vendor/carrier compliance	Impact analysis
Picking	Trailer manifesting	Traffic management
Packing and consolidation	Configurability	Import/export management
Shipping	Returns	Application Service Provider (ASP) supply
	Pick/put to light	
	Yard management	
	Wave management	
	Labour management	
	Task interleaving	
	Flow-through processing	

### 7.2.1 | NATURE AND IMPORTANCE OF A WAREHOUSE

Warehouse management provides a path to product-based organisations to manage their warehouse in a desirable or satisfactory way. This enables organisations to lower down wastage in terms of space and labour hours and assures more efficient inventory utilisation.

A warehouse is an integral part of supply chain management which holds goods before they are shipped and delivered to customers. Basically, production and consumption do not take place simultaneously. Thus there is a gap between the two. Warehousing bridges that gap by storing goods between these two processes and further creates time utility.

The importance of warehouses is explained as follows:

- They enable the storage of raw material, finished goods, semi-finished goods, goods in transit, seasonal goods, etc.
- They enable the efficient distribution of goods; for example, storage of crops after harvesting to distribution in the areas where there are shortages.
- They also ensure stable prices, as stored output can be used during the time of low production.
- They also enable grading, picking and branding of goods.
- They also provide perfect space for the preservation of perishable commodities. For example, storage of meat, vegetables and fruits in cold storage.
- They are also used to improve the quality of products as they mature, for example, wine storage.
- They ensure proper supply during the breakdown in production or during the unpredictable increase in demand.

- They are used to protect goods during unfavourable climate conditions.
- They reduce the risks of theft and damage of products.

## 7.2.2 | TYPES OF WAREHOUSES

A warehouse is a place to store the stock or the inventory. Most of the tasks that occur in a warehouse are related to inventory management. These tasks include accumulating the receipt of products, issuing of products, recording changes and tracking the movement of inventory. The role of a warehouse is, at times, considered to be processing the inventory from entry to exit. Also, it is considered to be a simple storage facility for products in transit from the point of origin to the point of destination. These days warehouse management plays a pivotal role in providing effective customer service. The warehouses are mainly of three types. These are explained as follows:

- **Private warehouses:** These are proprietary warehouses that are owned by manufacturers, producers or traders to store exclusively for their own stock. Generally, these warehouses are maintained by individuals near their manufacturing units according to their convenience. For example, a farmer constructs a warehouse near his fields, and a manufacturer stores products in the warehouse ahead of shipment. The design and facility are formed based on the nature of products to be stored.
- **Public warehouses:** These provide storage facilities to the general public on a rental basis. These warehouses may be owned by an individual, a partnership firm or by an organisation. These warehouses are to be used by manufacturers, wholesalers, exporters, importers, government agencies, etc., after paying a certain amount of fee. An organisation that owns a public warehouse needs to obtain a license from competent authorities. In general, public warehouses are used for low quantity storage and are preferred by organisations or individuals entering new markets or by organisations dealing in seasonal products. The owner of goods acts as an agent under public warehousing.
- **Contract warehouses:** These provide receiving, storage and shipping facilities to their clients as per the warehousing contract. Contracts are made between both the parties. These contracts are generally long-term in nature. A contract warehouse allows normal business expansion and contraction in a cost-efficient manner. Fee for a contract warehouse depends on a number of transactions and the quantity stored. Contract warehouses are most beneficial in the case of a new business or for businesses entering a new market. Organisations go for contract warehousing when they desire isolated cost centres or significant savings, want experienced and reliable business back-up, and seek to minimise personal risk or liability.

Apart from these three types of warehouses, there are other types of warehouses as well. These are discussed as follows:

- **Bonded warehouses:** In these types of warehouses, basically imported goods are stored in a secure area before the customs or import duty is paid by the importer. These warehouses are owned or licensed by the government. However, in some cases, the government issues license to a third party to own and maintain bonded warehouses under mandatory regulations.

## NOTES

- **Co-operative warehouses:** These are owned, managed and handled by co-operative societies and cater to storage facilities at low rates; for example, a storage facility operated by a farmer's cooperative society.
- **Raw material and component warehouses:** These are maintained to store an adequate inventory level of raw materials for production; for example, coal storage in a thermal power plant.
- **Work-in-progress warehouses:** These provide storage facilities for semi-finished products; for example, raw wine storage facility to make it more mature, and a storage facility for non-ripened fruits.
- **Finished goods warehouse:** These provide storage facilities for finished goods before distribution or selling; for example, a warehouse inside an automobile-manufacturing plant to store two-wheelers before distribution.
- **Distribution warehouses:** Here items for distribution are stored. Generally, distribution warehouses are maintained by manufacturing organisations to store items which are to be delivered to distributors.
- **Fulfilment warehouses:** These undertake the process of receiving, packaging and shipping orders for goods. These are the most appropriate for e-commerce organisations where they sell products directly to customers.
- **Local warehouses:** These are commonly used by organisations that work on the sales point system or franchise system and follow up the operation on the basis of customer requirements.
- **Value-added service warehouses:** These are maintained not only to provide storage facilities, but also value-added services, i.e., assembly, kitting and packaging.

## SELF ASSESSMENT QUESTIONS

1. \_\_\_\_\_ warehouses are proprietary warehouses that are owned by manufacturers, producers or traders to store exclusively for their own stock. Generally, these warehouses are maintained by individuals near their manufacturing units according to their convenience.
2. A contract warehouse allows normal business expansion and contraction in a cost-efficient manner. (True/False)

### 7.3 TYPES OF WAREHOUSE OPERATIONS

The main function of any warehouse is to receive larger quantities of products, break them into smaller ones and distribute them to users.

The process of warehousing takes place in five stages as shown in Figure 1:



FIGURE 1: Process of Warehousing

They are discussed as follows:

- **Receiving:** Receiving begins with an advance notice regarding the arrival of goods. It allows warehouses to schedule receipts and unloading in order to ensure coordination between other activities within the warehouse. At this stage, a product typically arrives in larger quantities from upstream and most activities are performed by machines and equipment. Thus, there are fewer labour requirements at this stage. On the contrary, downstream warehouses are generally more labour-intensive.
- **Putting away:** Before a product can be stored, it is important to determine an appropriate location. This involves managing the second inventory of storage locations, where the product is going to be placed. All information regarding the availability of storage locations must be in order as per the record. When the product is put away, it is important that the storage location, where the product is being stored, is properly examined. It requires more labour as the product needs to be moved to their storage locations.
- **Storage:** The basic function of a warehouse is to store goods and bridge the gap between the production and consumption of goods. The product remains inside the warehouse before it is going for order picking.
- **Order picking:** Order picking, also called order preparation, is the process of taking and collecting items in a certain quantity prior to shipment as to deliver customer's orders. At the time of order picking, it is mandatory for a warehouse to maintain the necessary documents and records and the set schedule for shipping. Pick lines are also required to be maintained at this level as these lines suggest what to pick in what quantity. In general, it is economic to batch single line orders as there is no need to sort while picking.
- **Packing and shipping:** Packing is considered to be more labour-intensive as each customer order is required to be handled individually. Moreover, it is to be ensured that each order is complete and accurate according to the needs of customers. Also, on request, in some cases, warehouses take the responsibility for packaging and branding of the products on behalf of the manufacturer. For example, a bottling facility of a soft drink manufacturer. Shipping is deemed as the ultimate process in warehousing and one of the most key aspects. Various tasks performed in a warehouse include weighing each lot, recording product shipment information and labelling the address.

The major types of operations performed by warehouses are as follows:

- **Protection of goods:** Warehouses protect goods from theft, loss or damage from unfavourable climate conditions, which may lead to huge losses to the organisation. In this manner, a warehouse has special arrangements based on the nature of goods.
- **Risk bearing:** Once goods are transferred to the warehouse, the related risks are also transferred to the warehouse keeper. Warehouses are responsible to return goods in a good condition as they are received and the warehouse is responsible for any kind of theft or damage as per the warehouse contract. Thus, a warehouse takes all precautions on behalf of the owner of goods.

## NOTES

- **Financing:** The owner or depositor of goods gets a receipt or a warrant immediately after he deposits goods. Receipt or warrant is proof of submission of goods. A depositor can take loans from banks and other financial institutions by submitting this warrant as security.
- **Processing:** There are certain commodities which are not healthy to consume in the form they are produced and processing is required to make them consumable. For example, the quality of wine improves as it gets more mature, pulses need polishing after harvesting, and raw fruits need to be ripe. A warehouse undertakes these responsibilities on behalf of owners.
- **Stock rotation:** Under stock rotation, the oldest units are arranged in inventory before the newer ones, just to make sure that they can be sold at first. For example, a departmental store will arrange goods on shelves by placing older products ahead of new products.
- **Cycle counting:** Under cycle counting, a small sample of inventory is counted inside the warehouse at any particular place and this sample represents the count of all items in the store. It increases efficiency as the entire inventory can be just by choosing samples from each unit.

## SELF ASSESSMENT QUESTIONS

3. The basic function of a warehouse is to store goods and bridge the gap between the \_\_\_\_\_ and the consumption of goods.
4. Under stock rotation, the new units are arranged in inventory before the older ones. (True/False)

## 7.4 WAREHOUSE LOCATION

The location of warehouses is directly related to market coverage and the effectiveness and efficiency of the distribution system. Thus, an organisation should locate its warehouse to get closer to its target customers.

Historically, a warehouse can be viewed as a large box used to store surplus inventory for a long period of time. But, nowadays, warehouse facilities have become distribution activity hubs that add value by not only storing goods, but also processing them. Now, there is focus on productivity and operational efficiency. If there is proper planning, then architectural design, construction and operational know-how can be done easily in an efficient manner. When designing a warehouse, it is important to understand an interrelationship between customer service and costs.

When a product is stored in convenient locations, it is easy to retrieve when requested by a customer. The various factors that need to be considered while choosing the warehouse location are as follows:

- **Layout and flow of building:** The desired or optimal layout of any warehouse can be determined according to operations conducted under it. The type of equipment stored in the warehouse is restricted by the ceiling height and column spacing. It ensures that the layout or product can be rightly fit in the given space.

- **Availability of skilled workforce:** Locating a warehouse in a remote area can definitely be cost-effective but finding skilled labour and workforce can be an arduous task. Hence, it is important to choose a warehouse located in the area where there is an adequate supply of labour. It is also important to consider whether the area has a seasonal supply of workers. If yes, then this will hamper an organisation's needs.
- **Intensity of use:** The location of a warehouse also gets affected by the frequency or intensity of operations inside the warehouse. In the case of the light assembly, less intensive usage will work better. However, certain factors, such as emissions, noise level and the availability of outdoor storage need to be considered. These needs or factors can influence target future operations.
- **Proximity to major linkage:** It involves means of transport to be used, i.e., land, rail, water or air transportation. It is important that the location site of a warehouse is easily accessible by any of these means of transport depending on the preference of the organisation. On the other hand, proximity to customers is another important factor to be considered.
- **Material-handling capacity:** It includes the availability of handling equipment, storage facility and staging facility. It can be moving, packing and storing of stock in any form or it occurs whenever material is moved in a warehouse.
- **Size:** It is important for warehouse capacity to accommodate inventory accordingly and it should be fit inside the organisation. For a start-up organisation, it is essential to make sure that there is enough room around the warehouse to make sure that it will not create any problem for their future expansion. A warehouse facility must be capable of accommodating inventory and should fit in the size of the organisation. For start-ups and new organisations, it is important to ensure that there is enough room around the facility for expansion. This ensures proper utilisation of time and money, with healthy business growth.
- **Regulations:** Before buying a warehouse, one has to consider all regulations and policies in the concerned location. It becomes significant because there are certain areas or locations in which the government does not allow the storage of certain products, for example, the prohibition of LPG storage facility in residential areas.

#### SELF ASSESSMENT QUESTIONS

5. The location of a warehouse also gets affected by the frequency or intensity of operations inside the warehouse. (True/False)
6. When designing a warehouse, it is important to understand an interrelationship between \_\_\_\_\_ service and costs.

## 7.5 GROWTH OF E-FULFILMENT AND ITS EFFECT ON WAREHOUSING

The world of e-commerce has witnessed a great turnaround ever since its genesis. Earlier, most e-commerce businesses started at a small level or just for experiment, but later, they evolved as a prominent growing channel. For instance, according to 'Naspers' report', initially Flipkart has spent only ₹ 4,00,000 to set up its e-commerce website and now it has captured a healthy market share of more than 55% in India. Nowadays, the e-commerce industry has seen a healthy growth, and e-commerce organisations handle this growth by employing more staff, with more shifts and

## NOTES

enhanced storage capacity. E-retail is growing at a very fast pace and it is also pushing the need for e-commerce warehousing that requires a substantial infrastructural investment. The size of e-commerce in India is minuscule as compared to the physical market. However, e-commerce is one of the fastest growing industries in the country. One of the biggest challenges for online retail brands is to deliver a variety of products at the customer's doorstep.

E-commerce warehouses are mega e-fulfilment centres with a floor area of up to 1 million square feet for the storage of products until online orders come. Generally, these warehouses are placed near parcel hubs. For example, Flipkart is constantly increasing its number of regional warehouses across India in order to gain low transportation costs and timely delivery.

E-fulfilment is applicable when an organisation sells its products directly to its customers or end users via means of physical mail, e-mail, catalogues and various other modes of online shopping. In general, e-fulfilment includes various activities, such as receiving, packaging and shipping order of goods.

**How does e-fulfilment work?**

Many of us have shopped online at one point or another in our lives. However, not everybody understands the process through which an order goes from online to a customer's doorstep. Basically, e-commerce orders start when a customer clicks 'Buy now' button. Once they click buy now, then all information of the order is transferred to retailers or merchants through 'Order Management System (OMS)'. OMS include product information, the quantity, any auxiliary services such as gift wrapping that the customer has chosen for that order.

Once the order management system has processed all information, it is transferred to the Warehouse Management System (WMS). This system incorporates order data and warehouse related data, i.e., the location of the item on the floor, shipping charges, etc. Therefore, the warehouse staff must be skilled enough to properly pick and pack the product as per customer order.

Once the warehouse management system processes that order, it is handled to the warehouse. In the warehouse, there is a pick staff which goes out onto the warehouse floor and selects those items for which order has been placed.

When the picking staff selects and picks that order, it is transferred to the packing station. At the packing station, the warehouse packing employee places the order inside the box. Packaging also includes any customised packing and gift wrapping services as per the customer's preference. At this point the packing staff also double-checks the order accuracy and its quality.

Once the order is packed and ready to be shipped, it goes on to the shipping dock. When this order is getting ready for shipment, it goes to ray optimisation to ensure that the package has a correct shipping method depending on what customers have selected. Also, it should be ensured that customers get the best optimised shipping rates on the packages that are going out.

Once the order is ready to go out, it is loaded onto the truck and headed over to the customer's door step. Taking feedback from customers plays an important part in the self-grooming of any business. Then, last but not the least, customers share their

feedback regarding shipping, packing and the product that they buy, which may be positive or negative.

### SELF ASSESSMENT QUESTIONS

7. When the picking staff selects and picks that order, it is transferred to the \_\_\_\_\_ station.
8. E-commerce orders end when a customer clicks the 'Buy now' button. (True/False)
9. Match the following:

List 1	List 2
1. Order Management System	a. provides storage facilities for semi-finished products
2. Stock rotation	b. refers to assimilating and accumulating products in a specified quantity prior to shipment to fulfil customer's orders
3. Order picking	c. the oldest units are arranged in inventory before the newer ones
4. Work-in-progress warehouse	d. includes product information, the quantity, and any auxiliary services like gift wrapping that the customer has chosen for that order
5. Bonded warehouse	e. imported goods are stored in a secure area before the customs or import duty is paid by the importer

- a. 1-d, 2-c, 3-a, 4-e, 5-b
- b. 1-e, 2-d, 3-b, 4-e, 5-c
- c. 1-d, 2-c, 3-b, 4-a, 5-e
- d. 1-c, 2-b, 3-a, 4-e, 5-c

### ACTIVITY

Visit an organisation that also has an e-commerce portal and take a look at the process which initiates once an order has been placed by a customer. Also, visit the storage area of the organisation and see how the product goes through various stages. On the basis of your observation, make a report of the activity.

## 7.6 SUMMARY

- A warehouse acts as an integral part of logistics that stores products between the point of origin and the point of consumption.
- Warehousing involves preparing products for reshipment with an ultimate objective to uninterrupted delivery, which shares its benefits in terms of a higher degree of customer service that leads to customer satisfaction.
- A warehouse plays an important role in the supply chain of an organisation by holding or storing goods. There is a need to store a product before it is being

## NOTES

shipped to customers as all products produced cannot be quickly delivered to customers.

- These days organisations manage their warehouses in such a manner that they facilitate improved lead times, reduced logistics costs and increased competitive advantage.
- Warehouse management provides a path to product-based organisations to manage their warehouse in a desirable or satisfactory way.
- Private warehouses are owned by manufacturers, producers or traders to store exclusively for their own stock. Generally, these warehouses are maintained by individuals near their workplaces according to their convenience.
- Public warehouses provide storage facilities to the general public on a rental basis. These warehouses may be owned by an individual, a partnership firm or by an organisation. These warehouses are to be used by manufacturers, wholesalers, exporters, importers, government agencies, etc.
- A finished goods warehouse provides storage facilities for finished goods before distribution or selling.
- A fulfilment warehouse undertakes the process of receiving, packaging and shipping orders for goods. This is the most appropriate for e-commerce organisations, where organisations sell products directly to the customers.
- Receiving begins with an advance notice regarding the arrival of goods. It allows warehouses to schedule receipts and unloading in order to ensure coordination between other activities within the warehouse.
- Packing is considered to be more labour-intensive as each customer order is required to be handled individually.
- Under cycle counting, a small sample of inventory is counted inside the warehouse at any particular place and this sample represents the count of all items in the store.

## 7.7 KEY WORDS

- **Order picking:** It refers to taking and assimilating items in a certain quantity prior to shipment as to deliver customers' orders.
- **Public warehouses:** They provide storage facilities to the general public on a rental basis. These warehouses may be owned by an individual, by a partnership firm or by an organisation, and can be used by manufacturers, wholesalers, exporters, importers, government agencies, etc., after paying a certain amount of fee.
- **Warehouse Management System (WMS):** It is basically a software that is used to track and manage the activities of a warehouse. It tracks and maintains all information related to the arrival and shipping of products in the warehouse.
- **Warehouse:** It is an integral part of supply chain management which holds and preserves goods before they are shipped and delivered to customers.
- **Work-in-progress:** It refers to a semi-finished product that requires more processing to make it consumable.

## 7.8 CASE STUDY: ESTABLISHING A WAREHOUSE FOR RAM & CO.

Ram & Co. is an organisation that deals in the garments business. The company had its own manufacturing and distribution system, and had its presence across Delhi. It wanted to expand its operations beyond Delhi and was mulling at options of establishing a warehouse and a manufacturing unit in Haryana. This thought of expanding business in Haryana was because of the easy availability of land and it was a lucrative option as compared to other states.

The owner of Ram & Co. was searching for a place to set up its own manufacturing unit and a warehouse in Haryana. Various factors had to be taken into account before it set up its warehouse and other establishments as it would facilitate in a seamless flow of operations. Various factors that the owner of Ram & Co. had contemplated, such as the availability of raw materials near the warehouse, whether skilled labour and the sufficient workforce, were taken into consideration. There was proximity of transport facility so as to make the products reach the desired location within time. After considering all these factors, the owner of Ram & Co. acquired land in Samalkha, Haryana and set up a manufacturing unit and two warehouses one for storing raw materials and the other for storing finished goods since Ram & Co. had also launched its own e-commerce site where consumers can buy products via ordering them online. The company had also implemented Warehouse Management System (WMS) to cater to customers' needs in a time-bound manner.

A number of activities were performed in the warehouse, such as weekly inspection of raw materials and finished goods to check its condition. Since Ram & Co. also had provided an e-commerce facility for its customers, the employees in the warehouse had to pick orders pertaining to the request of customers and pack them for shipment. After two months of commencement, the work was streamlined and everything worked in tandem.

### QUESTIONS

1. Why was the owner of Ram & Co. thinking of expansion in Haryana?  
(**Hint:** Easy availability of land and it was a lucrative option.)
2. What were various factors that had to be considered before setting up the establishments?  
(**Hint:** The factors to be considered were the availability of raw materials, skilled labour, transport facility, etc.)
3. Why did the owner of Ram & Co. construct two warehouses?  
(**Hint:** One for raw materials and the other for finished goods.)
4. What did Ram & Co. introduce to facilitate the smooth flow of warehouse operations?  
(**Hint:** The owner introduced e-commerce site and Warehouse Management System.)

## NOTES

5. What were the activities conducted in the warehouse?

(**Hint:** Weekly inspection of raw materials and finished goods, order picking, etc.)

### 7.9 EXERCISE

1. Explain the meaning and concept of a warehouse.
2. Elaborate on warehouse management system and activities under it.
3. Describe various types of warehouses.
4. What are the types of important warehouse operations? Explain your answer with the help of a flowchart.
5. Explain any five factors to be considered while selecting a convenient warehouse location.

### 7.10 ANSWERS FOR SELF ASSESSMENT QUESTIONS

Topic	Q. No.	Answer
Concept of a Warehouse	1.	Private
	2.	True
Types of Warehouse Operations	3.	production
	4.	False
Warehouse Location	5.	True
	6.	customer
Growth of e-fulfilment and its Effects on Warehousing	7.	packing
	8.	False
	9.	c. 1-d, 2-c, 3-b, 4-a, 5-e

### 7.11 SUGGESTED BOOKS AND E-REFERENCES

#### SUGGESTED BOOKS

- Richards, G. *Warehouse Management*. (2013)
- Tompkins, J., & Smith, J. (2012). *The Warehouse Management Handbook*. Raleigh, N.C.: Tompkins Press.

#### E-REFERENCES

- Warehouses Types: 5 Types of Warehouses – Explained!. (2019). Retrieved 2 December 2019, from <http://www.yourarticlelibrary.com/retailing/warehouses-types-5-types-of-warehouses-explained/48302>
- Warehousing Definition | Operations & Supply Chain Dictionary | MBA Skool-Study.Learn.Share. (2019). Retrieved 2 December 2019, from <https://www.mbaskool.com/business-concepts/operations-logistics-supply-chain-terms/15611-warehousing.html>

# Functions of Warehousing

## Table of Contents

---

- 8.1 Introduction
- 8.2 Functions of a Warehouse
  - Self Assessment Questions
- 8.3 Roles and Responsibilities of a Warehouse Manager
  - Self Assessment Questions
- 8.4 Benefits of Warehousing
  - 8.4.1 Economic Benefits
  - 8.4.2 Operational/Service Benefits
    - Self Assessment Questions
- 8.5 Summary
- 8.6 Key Words
- 8.7 Case Study
- 8.8 Exercise
- 8.9 Answers for Self Assessment Questions
- 8.10 Suggested Books and e-References

**LEARNING OBJECTIVES**

*After studying this chapter, you will be able to:*

- Explain the functions of a warehouse
- Discuss the roles and responsibilities of a warehouse manager
- Describe the benefits of warehousing
- Discuss various economic benefits of warehousing
- Explain various operational/service benefits of warehousing

**8.1 INTRODUCTION**

In the previous chapter, you have studied the concept of warehousing and different warehousing operations. In order to manage the supply chain in an effective manner, it is essential for an organisation to meet the demands of its customers on time. For this purpose, organisations store their products in warehouses. Thus, you can say that a warehouse plays an important role in managing the supply chain. Let us discuss various functions and benefits of warehousing in the present chapter in detail.

A warehouse is a place used to store inventory. Most tasks that occur in a warehouse are related to inventory management. These tasks include collecting receipt of products, issuing of products, recording changes and tracking the movement of the inventory. At times, the role of a warehouse includes processing of the inventory from entry to exit, and, at times, it is limited to providing storage facility for products in transit from the point of origin to the point of destination.

Nowadays, warehouse management has an important role in effective customer service. Warehousing can play a pivotal role in minimising supply chain inefficiencies, improving the value addition during the logistical flow of products and inventory management that includes consolidation and customisation of inventory.

Before the goods are shipped to the point of consumption, a warehouse serves a place where the goods can be stocked temporarily. A warehouse is an important cog in the supply chain of products as it forms a crucial part of the chain. If a warehouse is eliminated from the supply chain, the entire logistics industry would come to a standstill. The smooth supply of goods is only possible because of warehouses. They form the spine of the supply chain. The size of the warehouses varies depending upon the number and nature of goods.

This chapter explains the different functions performed by warehouses. Next, the chapter discusses the roles and responsibilities of a warehouse manager. Finally, the chapter explains various benefits of warehousing.

**8.2 FUNCTIONS OF A WAREHOUSE**

The prime function of a warehouse is to provide the facility of storage for the goods which are surplus with the organisation. A Warehouse does not only mean storing inventory, but also involves several other functions. For example, a warehouse

manager receives a bulk of ordered goods. On receiving the goods, the warehouse manager needs to check whether the goods have arrived as per the order placed or not. If there is some correction, then the manager needs to inform his seniors. After that, the warehouse manager sends goods for storage where they are categorised and stored in a proper storage system. When goods are required for production/sales purposes, the warehouse manager needs to check their availability and sort them according to the order. Not only this, but the manager also needs to transport goods to the production centre/store through a proper medium. Thus, there are a set of activities that are common to most warehouses. These are as follows:

- **Receiving:** This includes tasks related to the receipt of all incoming products at the warehouse, ensuring that the quality and quantity of the received products are as ordered, and then disbursing the products to storage.
- **Pre-packing (if required):** This happens when products are received in bulk from the supplier and are required to be packaged individually in merchandisable quantities.
- **Transporting to the appropriate storing place:** This is also referred to as put away. This includes material handling, location identification and placement.
- **Storage:** The method of storage depends on the size, quantity and the handling characteristics of the product.
- **Order picking:** This task involves physical picking of the product from the storage place to meet the demand.
- **Packaging or pricing (if required):** This refers to activities normally left till the last moment to avoid repricing as the inventory sits in storage.
- **Sorting:** This includes the shipment of products as per their packaging and destination.
- **Consolidation and shipping:** This includes checking orders for completeness and preparing shipping documents, such as bills of lading, weighing shipments, loading trucks and related tasks.
- **Claim settlements:** Any transit damage material and material rejection claim settlements are done in the warehouse to control shrinkage.

The activities of a warehouse are depicted in Figure 1:

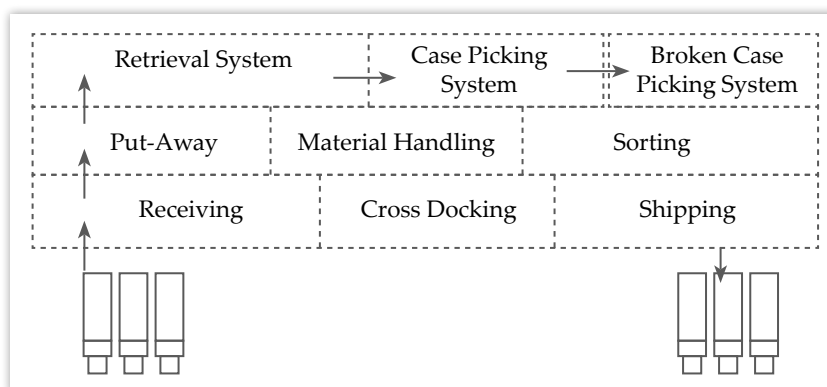

FIGURE 1: Activities of a Warehouse

## NOTES

The basic functions of a warehouse include the following:

- **Store goods in a systematic and orderly manner:** This includes the storage of products from the stage of production till their consumption.
- **Provide protection:** This includes protecting products from natural factors, such as heat, wind and rain. It helps reduce spoilage during storage.
- **Risk bearing:** After handing over the products to the warehouse, the responsibility of these products, including any losses on account of shrinkage, theft or damage, is borne by the warehouse operator.
- **Financing:** When products are deposited in a warehouse, the depositor gets a receipt and/or a warrant. This warrant or warehouse receipt can be used by the trader as collateral to take a loan from a financial institution.
- **Processing:** Certain commodities require some processing to make them consumable. For example, wood is seasoned and fruits are ripened. At times, warehouses perform such activities at the behest of the owner.
- **Transportation:** This facility is provided by some warehouses to certain depositors. It collects the product from the point of origin and delivers it to the desired location at the behest of the depositor.
- **Provide regular flow:** This includes commodities, such as rice and wheat, which are produced during a particular season, but are consumed throughout the year.
- **Easy handling:** Mechanical equipment in modern warehouses enables easy handling of products including loading and unloading.
- **Job creation:** Employment opportunities are created for skilled and unskilled workers in semi-urban areas.

The functions of the warehouses are shown in Figure 2:

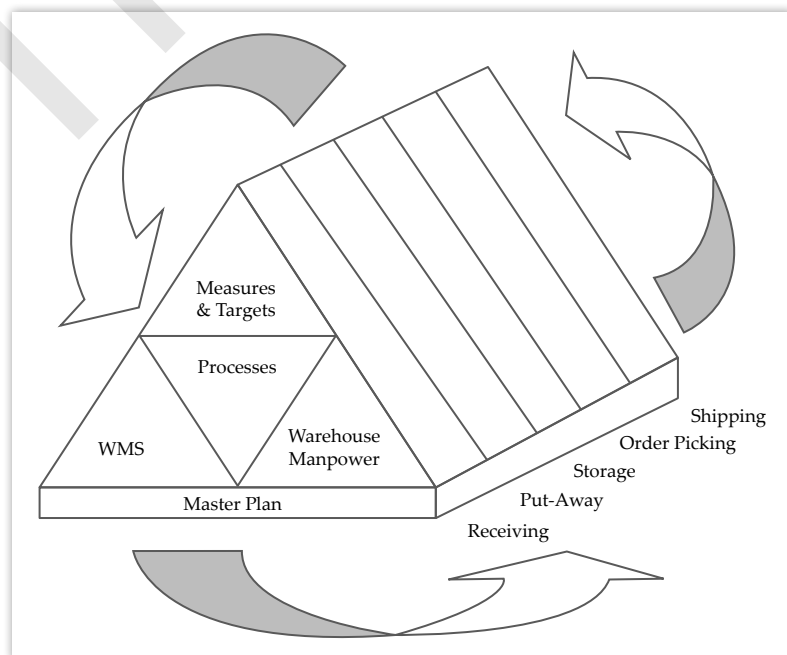

FIGURE 2: Functions of a Warehouse

**SELF ASSESSMENT QUESTIONS****NOTES**

1. The prime function of \_\_\_\_\_ is to provide the facility of storage for the goods which are surplus with the organisation.
2. The method of warehouse storage depends on the size, quantity and the handling characteristics of the product. (True/False)

**8.3 ROLES AND RESPONSIBILITIES OF A WAREHOUSE MANAGER**

Warehouse managers are responsible for organising and managing the receipt, storage and dispatch of inventoried items. Warehouse managers must have sound knowledge of distribution, logistics and transportation management to perform various functions of warehousing efficiently. Different roles and responsibilities of warehouse managers are as follows:

- To oversee warehouse functions to ensure methodical receipt, storage, inventory management and despatch of products
- To ensure that proper inventory management processes, principles and policies are followed in pursuance of warehousing tasks
- To administer and guide the junior staff (such as warehouse employees and other supervisors and labour). This is to facilitate timely and satisfactory completion of daily warehouse tasks while utilising various resources, i.e., warehouse equipment, such as forklift, pallet jack or hand truck, and as per organisational policies, rules and regulations, as desired
- To facilitate the professional development of the staff by utilising employee assessments, internal or external training programs, training records and audit techniques, as required
- To supervise the subordinate workforce by keeping an eye on daily work allocation and performance to ensure that the entire staff performs its duties while utilising duty reports and effective communication, as required
- To discuss the forecast of the required materials with the staff to ensure an uninterrupted flow of material without overstocking
- To suggest the reduction of inventories to comply with the overall objective of management
- To review the purchase documents and purchase orders supplied to the warehouse periodically to ensure an appropriate allocation of products to the appropriate location in the warehouse
- To ensure proper housekeeping in the warehouse by the appropriate person(s)
- To ensure sufficient stock of stationery, food and other items of general use
- To ensure the security of the warehouse
- To provide the management with updated reports on the current stock to enable high-level decisions

## NOTES

- To justify the replacement of worn-out equipment or purchase of new equipment to meet the needs of the warehouse
- To focus on shrink and claim settlements
- To follow product safety norms

Nowadays, the role of warehouse managers is influenced by e-commerce, globalisation, Just-In-Time techniques and collaborations along the supply chain. Warehouse managers are being asked:

- To handle a smaller and a greater number of transactions
- To track and store more products
- To provide more customised services
- To offer more value-added services
- To process more orders

## SELF ASSESSMENT QUESTIONS

3. Warehouse managers are not responsible for organising and managing the receipt, storage and dispatch of inventoried items. (True/False)
4. The role of warehouse managers is influenced by e-commerce, \_\_\_\_\_, Just-In-Time techniques and collaborations along the supply chain.

## ACTIVITY

Visit a grocery store in your vicinity and take a look at various warehouse functions performed at the store. Also, evaluate which activity saves time and efficiency.

## 8.4 BENEFITS OF WAREHOUSING

In the previous section, you have studied various functions of warehouses, and the roles and responsibilities performed by a warehouse manager. Efficient warehousing activities not only help in solving the purpose of storing products, but also help in managing the smooth functioning of various business functions. This further helps an organisation in providing, better customer service. Apart from this, efficient warehousing helps the organisation in dealing with several other issues. These are as follows:

- **Seasonal production:** Different agricultural products are harvested during different seasons, but they may be consumed throughout the year. Consequently, these products should be stored properly in warehouses, so that they can be made available to customers whenever they are needed. For example, agricultural products, such as fruits and vegetables, are harvested at specific times, but their demand occurs throughout the year.
- **Seasonal demand:** There are some products that have seasonal demand; for example, woollen garments are required during winters while umbrellas are required during the rainy season. These goods are produced throughout the year to

meet the seasonal demand. Therefore, such goods need to be stored in appropriate warehouses, so that they can be provided to consumers whenever required.

- **Large-scale production:** The goods are manufactured to meet the existing as well as the future demands for products. The organisations find it economical to manufacture goods in enormous volumes in order to earn the advantage of extensive production. Therefore, the products are produced in huge quantities, which require proper storage until they are moved out of the warehouses for sale. For example, the outdoor house decoration lights and crackers are produced the whole year, but are mostly sold only during the short festive season.
- **Quick supply:** Both the industrial and agricultural goods are produced at some specific places, but are consumed throughout the country. Therefore, it is essential to stock these goods near the place of consumption, so that these products are immediately available to customers as and when required.
- **Continuous production:** For ensuring uninterrupted production, factories require sufficient stock of unprocessed material. Therefore, there is a need to hold an adequate stock of raw material in warehouses.
- **Price stabilisation:** For maintaining a reasonable price level in the market, it is essential for organisations to keep an adequate amount of stock in the warehouse. Any scarcity in the supply of goods may increase their price in the market. Again, the excess supply may also lead to a fall in the prices of the goods. Effective warehousing enables organisations to maintain a balance in the supply of goods, which further leads to price stabilisation.

The benefits of warehousing can be divided into two categories as shown in Figure 3:

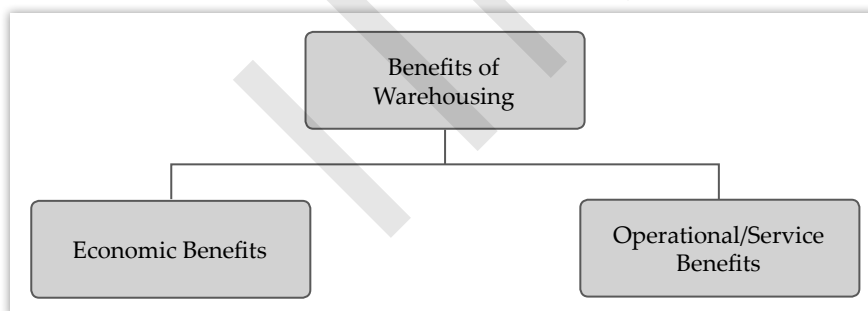

FIGURE 3: Benefits of Warehousing

### 8.4.1 | ECONOMIC BENEFITS

The economic benefits of warehousing are related to the reduction of overall logistics and supply chain costs. For example, if adding a warehouse in the logistics system reduces the overall cost of the supply chain by an amount more than the required investment and operational cost, then it helps in reducing the total cost. The four major economic benefits are:

- **Consolidation and break bulk:** It helps in reducing transportation costs by using warehouse competence to group shipment. In consolidation, the warehouse receives materials from various sources. The materials are formed in specified quantities into a large single shipment to the desired destination. Consolidation

helps in achieving the lowest possible freight rate, timely and controlled delivery, and reduced congestion at the customer's end.

The consolidation arrangement of warehousing is shown in Figure 4:

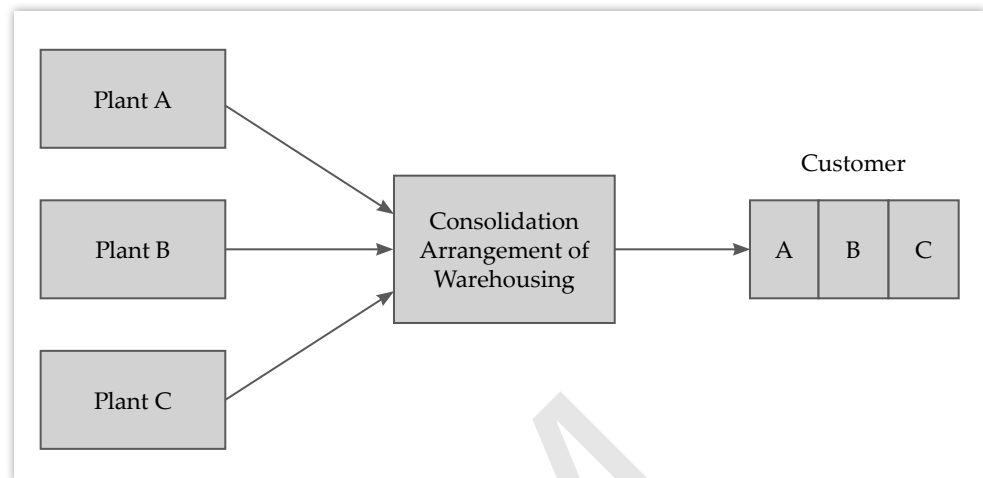

FIGURE 4: Consolidation Arrangement of Warehousing

Break-bulk arrangement of warehousing receives a single large shipment and arranges for the delivery for multiple customers. It helps in achieving economies of scale by transporting a larger consolidated shipment. Break-bulk arrangements split out individual orders and arrange for local delivery.

Break-bulk arrangement of warehousing is shown in Figure 5:

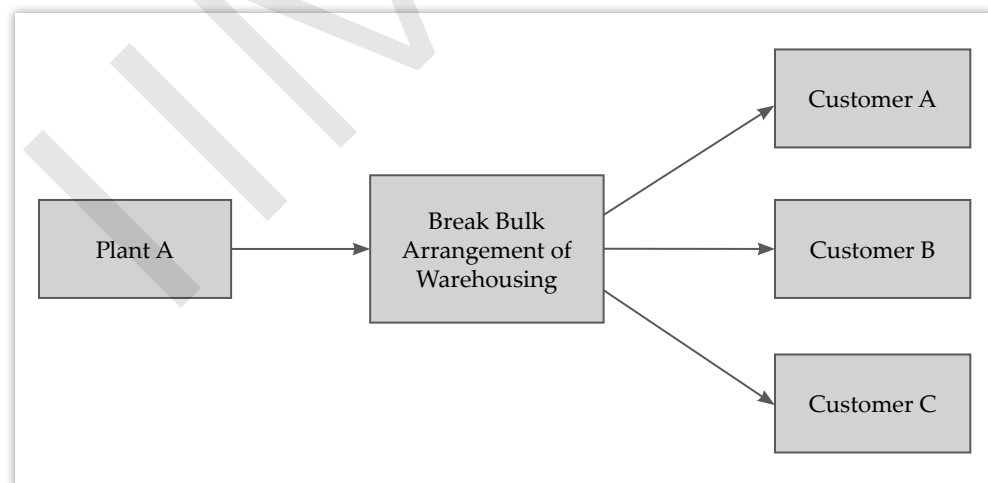

FIGURE 5: Break Bulk Arrangement of Warehousing

- **Cross-docking:** Cross-docking involves multiple manufacturers. In cross-docking, inventory from various origins is combined and then shipped to a destination in a pre-specified assortment. Cross-docking is extensively used in the retail sector to replenish fast-moving store inventories. Cross-docking requires exact on-time delivery from each manufacturer. The product is sorted by destination at the time when it is received and unloaded at the warehouse. Then, the product is moved from the warehouse to the delivery destination. The economic benefit of cross-docking includes a reduction in the handling cost as the product is not stored at the cross-dock facility.

Cross-docking arrangement of warehousing is illustrated in Figure 6:

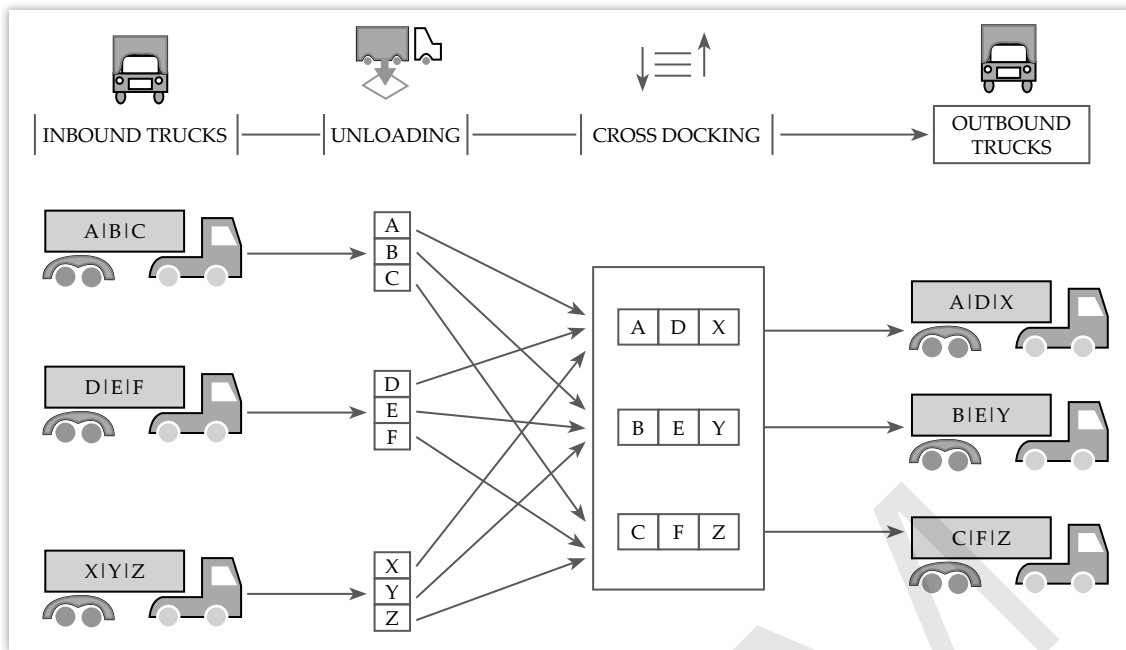

FIGURE 6: Cross-docking Arrangement of Warehousing

Source: <http://www.africawarehouses.com>

- **Processing:** Warehousing is also used for protracting production by undertaking processing and light manufacturing tasks. Postponing involves shifting the point of differentiation towards the end of the value-addition curve. This can be achieved in reality by deferring the operational process (differentiation process) to a later stage in the supply chain. A warehouse that has the capability of packaging/labelling enables an organisation to postpone final production until actual demand is known. Take an example where a manufacturer processes and packs vegetables in cans. However, cans are not labelled at the time of packaging. On receiving an order from a particular customer, the warehouse can fulfil final processing by labelling cans and finalising the packaging process.

Processing and postponement provide two economic benefits to a manufacturer. It helps in minimising the risk as final packaging is not completed until an order for specific labelling is received. Moreover, processing and postponement help in reducing the level of inventory as the final labelling and packaging configuration is transferred to the warehouses. This ultimately helps in reducing total system costs.

- **Stockpiling:** This warehousing service is provided for a seasonal product's storage. For example, several agricultural products are harvested at specific times, but are consumed throughout the year. Such a situation requires warehouse stockpiling to fulfil the market demand by providing an inventory buffer.

#### 8.4.2 | OPERATIONAL/SERVICE BENEFITS

Warehouse management is a part of logistics and supply chain management. Thus, it becomes necessary for a manager to manage the warehouses effectively for the

NOTES

smooth functioning of a supply chain. When a warehouse is justified on the basis of services, it may result in the improvement in time and place capability of the overall supply chain. For example, establishing a warehouse in the supply chain may increase cost, but it may also increase market share, revenue and profit. Operational/service benefits that can be achieved through warehousing are:

- **Stock spotting:** The selected quantity of a product is spot stocked in a warehouse to fulfil the customer order during an important marketing period. The manufacturer with limited or seasonal products is inclined to avail of this service. This is done by committing inventory in advance to the strategic markets.
- **Assortment:** In this, a combination of products is stocked according to the orders anticipated from the customer. The assortments represent multiple products from multiple manufacturers assorted as specified by the customer. For example, a sports gear shop may stock products from different manufacturers or special assortments as required by customers. Assortment warehouses improve service and reduce transportation costs by eliminating the number of suppliers and allowing large shipment quantities.
- **Mixing:** Warehouse mixing is similar to the break bulk process except that in mixing, several different manufacturer shipments are involved. In mixing, large quantity shipments that enjoy lower transportation rates are shipped from the manufacturing plants. After they arrive at the warehouse, a combination of products is made for each customer. This is useful when the factories are geographically separated by large distances.

A pictorial representation of warehouse mixing is shown in Figure 7:

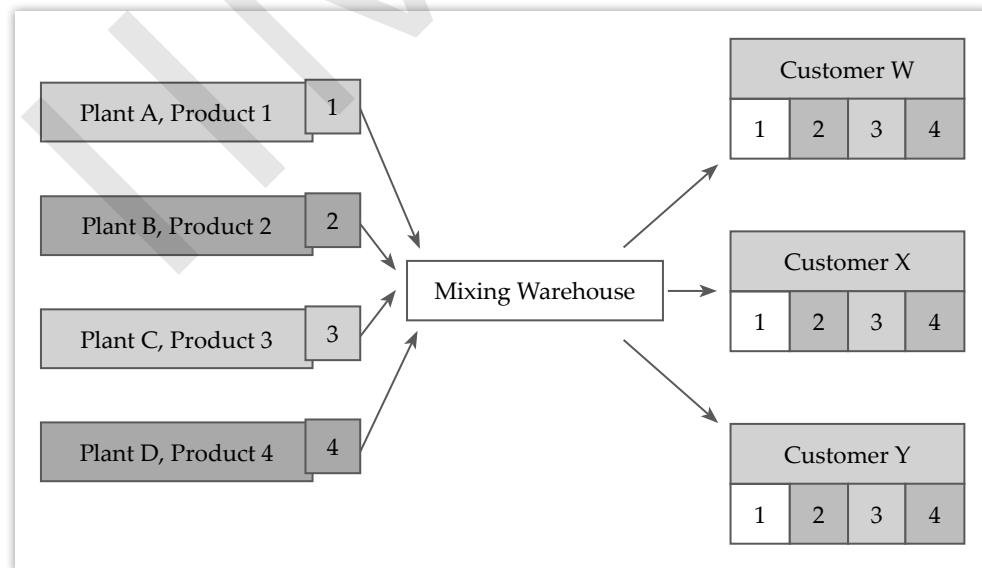

FIGURE 7: Warehouse Mixing

Source: <http://slideplayer.com>

- **Production support:** Production support warehouses provide a regular supply of components required in the production or assembly process in an economical and timely manner. The safety stocks are justified due to long lead times or variations in usage.

- **Market presence:** It is a major advantage of the local warehouses as local warehouses can be more responsive to customer's requirements and offer speedier delivery as compared to distant warehouses. Thus, these local warehouses often result in enhancing market share and increasing profitability.

#### SELF ASSESSMENT QUESTIONS

- \_\_\_\_\_ is extensively used in the retail sector to replenish fast-moving store inventories.
- Local warehouses often result in enhancing market share and increasing profitability. (True/False)
- Match the following:

List 1	List 2
1. Production support warehouses	a. ensures proper inventory management process, principles and policies are followed in pursuance of warehousing tasks.
2. Assortment	b. provide a regular supply of components required in the production or assembly process.
3. Warehouse manager	c. involves physical picking of the product from the storage place to meet the demand.
4. Order picking	d. a combination of products is stocked according to the orders anticipated from the customer.

- a. 1-b, 2-d, 3-a, 4-c                      b. 1-a, 2-b, 3-c, 4-d  
c. 1-d, 2-a, 3-b, 4-c                      d. 1-c, 2-d, 3-a, 4-b

## 8.5 SUMMARY

- A warehouse is a place used to store inventory. Most tasks that occur in a warehouse are related to inventory management. These tasks include collecting receipt of products, issuing of products, recording changes and tracking the movement of the inventory.
- The role of a warehouse includes processing of the inventory from entry to exit and, at times, it is limited to providing storage facility for products in transit from the point of origin to the point of destination.
- Warehousing can play a pivotal role in minimising supply chain inefficiencies, and improving the value addition during the logistical flow of products and inventory management that include consolidation and customisation of inventory.
- Consolidation and shipping include checking orders for completeness, preparing shipping documents, such as bills of lading, weighing shipments, loading trucks and related tasks.
- When products are deposited in a warehouse, the depositor gets a receipt and/or a warrant. This warrant or warehouse receipt can be used by the trader as collateral to take a loan from a financial institution.

## NOTES

- Mechanical equipment in modern warehouses enables easy handling of products including loading and unloading.
- Warehouse managers must have sound knowledge of distribution, logistics and transportation management to perform various functions of warehousing efficiently.
- Warehouse managers have to facilitate timely and satisfactory completion of daily warehouse tasks utilising various resources, i.e., warehouse equipment, such as forklift, pallet jack, hand truck, etc., and as per the organisational policies, rules and regulations as desired.
- Warehouse managers have to review the purchase documents and purchase orders supplied to the warehouse periodically to ensure an appropriate allocation of products to the appropriate location in the warehouse.
- Different agricultural products are harvested during different seasons, but they may be consumed throughout the year. Consequently, these products should be stored properly in warehouses, so that they can be made available to customers whenever they are needed.
- The organisations find it economical to manufacture goods in enormous volumes in order to earn the advantage of extensive production. Therefore, products are produced in huge quantities that require proper storage until they are moved out of the warehouses for sale.
- For maintaining a reasonable price level in the market, it is essential for organisations to keep an adequate amount of stock in the warehouse. Any scarcity in the supply of goods may increase their prices in the market.
- The economic benefits of warehousing are related to the reduction of overall logistics and supply chain costs.
- Break-bulk arrangement of warehousing receives a single large shipment and arranges for delivery for multiple customers. It helps attain economies of scale by moving the large consolidated shipment.
- Cross-docking is extensively used in the retail sector to replenish fast-moving store inventories. Cross-docking requires exact on-time delivery from each manufacturer.

## 8.6 KEY WORDS

- **Consolidation and shipping:** It subsumes checking orders for completeness, and preparing shipping documents, such as bills of lading, weighing shipments, loading trucks and related tasks.
- **Consolidation:** In consolidation, the warehouse receives materials from various sources. The materials are formed in specified quantities into a large single shipment to the desired destination.
- **Cross-docking:** It involves multiple manufacturers. It is used to combine inventory from multiple origins to a destination in a pre-specified assortment.
- **Order picking:** It involves physical picking of the product from the storage place to meet the demands of consumers.
- **Transportation:** It refers to the collection of a product from the point of origin and its delivery to the desired location at the behest of the depositor.

## 8.7 CASE STUDY: WALMART'S TECHNOLOGY-EQUIPPED WAREHOUSING SYSTEM

Walmart is a leading retail organisation in the world. Established in 1962 in Arkansas, US, by Sam Walton, it presently has 3,200 stores in the US as well as 1,100 stores in countries, such as the UK, Brazil, Mexico, Puerto Rico, Argentina, China, Germany, Korea and Canada. Walmart is famous for selling products at cheaper prices as compared to its competitors. It has achieved cost leadership due to its highly efficient warehousing and distribution centres, and supply chain network.

Walmart has more than 3,000 suppliers encompassing many suppliers, such as Procter & Gamble, Clorox, and Johnson & Johnson. However, in order to avoid excessive dependency over suppliers, the organisation does not purchase more than 4% of its total purchase volume from a single supplier. More than 85% of Walmart's products are supplied through its own warehousing and distribution centres. Walmart owns about 3,000 trucks and 12,000 trailers for the transportation of merchandise. On the other hand, its competitors rely on outsourcing the transportation of merchandise.

The application of innovative technology has helped Walmart in achieving a competitive advantage in the international retail market. The organisation is well equipped with the latest technological innovation including security barcoding, such as Radio Frequency Identification Devices (RFID). In the 1980s, when the whole world was fumbling with the idea of barcoding, Walmart implemented it in reality. The organisation installed RFID readers at several points, such as at the back of the warehouse, at receiving docks, near the garbage compactors, and between the distribution centre and store floor. The RFID technology helps Walmart stores in managing activities involved in stock distribution and warehousing. With RFID codes, the warehousing centres of Walmart easily identify the content of cartons without opening the packaging. RFID also helps Walmart's warehousing centres to register all the details related to sold items and replenishments made on the sales floor.

In addition, Walmart has also installed its own satellite network system. This system facilitates information sharing among different stores, warehouses and suppliers. The satellite network system has resulted in a substantial reduction in inventory cost of the organisation.

### QUESTIONS

1. How did Walmart achieved cost leadership over its competitors?  
(Hint: Highly efficient warehousing and distribution centres)
2. To avoid excessive dependency over suppliers, what was done by Walmart?  
(Hint: Supplied majority of its own warehousing and distribution centres)
3. What enabled Walmart to achieve a competitive advantage in the international retail market?  
(Hint: Security barcoding, such as Radio Frequency Identification Devices)
4. At which all places did Walmart install RFID readers?  
(Hint: Several points, such as at the back of the warehouse, at receiving docks and near the garbage compactors)

## NOTES

- Why did Walmart install its own satellite network system?  
(**Hint:** Information sharing and reduction in inventory cost)

**8.8 EXERCISE**

- Explain the basic functions of warehousing.
- Discuss the major roles and responsibilities of a warehouse manager.
- What are the economic benefits of warehousing?
- Discuss the major operational/service benefits of warehousing.
- Explain the operational/service benefits of a warehouse.

**8.9 ANSWERS FOR SELF ASSESSMENT QUESTIONS**

Topic	Q. No.	Answer
Functions of a Warehouse	1.	warehouse
	2.	True
Roles and Responsibilities of a Warehouse Manager	3.	False
	4.	globalisation
Benefits of Warehousing	5.	Cross-docking
	6.	True
	7.	a. 1-b, 2-d, 3-a, 4-c

**8.10 SUGGESTED BOOKS AND E-REFERENCES****SUGGESTED BOOKS**

- Richards, G. (2017). *Warehouse Management*.
- Tompkins, J. and Harmelink, D. (2011). *The Distribution Management Handbook*. New York: McGraw-Hill.

**E-REFERENCES**

- Your Article Library. (2019). *Warehousing: Functions and Types of Warehouses!*. [online] Available at: <http://www.yourarticlelibrary.com/marketing/warehousing-functions-and-types-of-warehouses/25849> [Accessed 4 Dec. 2019].
- Bayt.com. (2019). *What are the warehouse manager duties and responsibilities? - Bayt.com Specialties*. [online] Available at: <https://specialties.bayt.com/en/specialties/q/20994/what-are-the-ware-%20house-manager-duties-and-responsibilities/> [Accessed 4 Dec. 2019].

# Warehouse Location and Design

## Table of Contents

---

- 9.1 Introduction
- 9.2 Site Analysis
  - Self Assessment Questions
- 9.3 Product Mix Considerations
  - Self Assessment Questions
- 9.4 Warehouse Design
  - 9.4.1 Design Criteria
  - 9.4.2 Material Handling Technology
  - 9.4.3 Storage Plan
    - Self Assessment Questions
- 9.5 Aisle Width Decision
  - Self Assessment Questions
- 9.6 Summary
- 9.7 Key Words
- 9.8 Case Study
- 9.9 Exercise
- 9.10 Answers for Self Assessment Questions
- 9.11 Suggested Books and e-References

**LEARNING OBJECTIVES**

*After studying this chapter, you will be able to:*

- Explain how to perform site analysis for a warehouse
- Discuss the concept of product mixing
- Describe the warehouse design criteria and material handling technology
- Elucidate key storage plan pointers
- Explain how to perform aisle width decisions

**9.1 INTRODUCTION**

In the previous chapter, you studied the functions of a warehouse. The chapter discussed the roles and responsibilities of a warehouse manager. At last, the economic and operational benefits of warehousing had been described.

In this chapter, you will gain knowledge about the location and design aspects of building a warehouse. The process of building a warehouse can be divided into two aspects, i.e., location and design.

An efficient warehouse location and its design are the bases of an effective supply chain. A warehouse should be located at such a place and should be designed in such a way that it can serve the expectations of customers efficiently and in time. If the design of a warehouse does not adapt to unexpected or as per change in products or operations, it may affect the entire supply chain.

Establishing a warehouse at the correct location is very pertinent to maintain the smooth flow of supply operations. Organisations meticulously plan for the location, design and size of a warehouse because these factors cannot be altered once the warehouse is set up. For maintaining a healthy or seamless flow of goods, it is prudent to set up a warehouse at the place where goods transit time is minimum.

In case the warehouse is located far away from the ultimate destination, the transportation cost will add up to the product cost. The demographics should also be assiduously considered as per the magnitude of goods handled. The nature of goods and their perishability index will be affected by the warehouse.

This chapter describes the concept of site analysis and the key concepts to consider while selecting a location for a warehouse. Further, the chapter explains the product mix considerations. The chapter also discusses design criteria, material handling technologies and storage plans that need to be considered while designing a warehouse. In the end, the chapter makes you familiar with the considerations of aisle width in a warehouse.

**9.2 SITE ANALYSIS**

The selection of a warehouse site is a difficult process in which various intangible and tangible aspects are required to be taken care of. Though various current methods

that support the process are oriented towards cost considerations, organisations should also consider both quantitative and qualitative aspects by following an analytic approach.

**Terry Harris**, managing partner, Chicago Consulting, had advised the following about the site/location of a warehouse: *Start the selection process by realising that a facility's location performs one main function getting a company close to its customers. The key performance issue for a warehouse is lead time because we are an impatient society.*

The decision to select a warehouse site has a substantial effect on transportation types, the customer service level and the markets that can be served. Though the process of warehouse site selection is complex, involving both qualitative and quantitative criteria, major changes in the organisation's operational environment further enhance its complexity. Such changes include a decrease in response times, demand for flexible delivery services and an increase in replenishment cycle lead times.

Organisations need to decide whether a single warehouse can serve customer needs across the nation or they need to establish warehouses across the nation.

In the words of **Terry Harris**, *a company with one warehouse in Atlanta, for example, would not locate another facility in Chattanooga to serve national demand. It would choose a West Coast city, or perhaps Dallas or Chicago.*

Organisations need to set up their warehouses on the basis of cost and customer service objectives. Some other important considerations while choosing a warehouse are as follows:

- To have a low-cost network
- To establish a high service network
- To build a network that is superior to competitors' network

Most of the networks are laid out for minimising costs within a specific objective of service. For example, one objective can be to design a network that has the lowest possible distribution cost and may deliver 90% of customer orders within the first four days of ordering and the rest within 10 days.

Generally, warehouse network designers ignore the aspect of competitors. Good designers who consider warehouse and service locations of competitors end up setting up a warehouse that provides better sales and service levels.

While analysing a warehouse site, organisations must understand what they require to offer to their customers. Some important questions to be addressed are:

- Do customers require shorter lead times or high availability levels or both?
- Is it necessary to locate the warehouse near customers?
- Will it result in any loss if a competitor delivers better service?
- If the services are improved, will the improvement result in an increase in sales?

## NOTES

Ignoring the role of customer service can cause an organisation to spend more and relocate its warehouse more often. In addition, while contemplating location decisions, network designers need to consider four important budget costs which are as follows:

- **Labour costs:** These costs are incurred in every warehouse, irrespective of the throughput and size of the warehouse.
- **Facility costs:** These costs are dependent on whether the inventory is placed in a single warehouse or distributed into many.
- **Inventory costs:** Inventory costs increase with an increase in the distribution network. Organisations with large distribution networks require additional inventory in their warehouses to handle out-of-stock inventory conditions.
- **Inbound and outbound transportation costs:** These costs decrease with an increase in the network as the more the number of warehouses, the higher is the role of inbound shipping, which is more effective than the outbound one.

Warehouse designers must also consider the interdependency of these costs. Once an organisation has decided on a general location for the site of its warehouse, it must determine whether it should be a rural setting or an urban one. For example, Walmart generally sets up its warehouses in rural areas because, in such areas, labour cost is low, although transportation costs go higher.

Organisations have various options when it comes to selecting a specific location type. They can look for an existing property or build a new one as per their needs. In the case of generic needs, they can lease or buy an existing building.

## SELF ASSESSMENT QUESTIONS

1. Organisations need to set up their warehouses on the basis of cost and customer service objectives. (True/False)
2. Selection of a \_\_\_\_\_ site is a difficult process in which various intangible and tangible aspects are required to be taken care of.

## ACTIVITY

Visit a warehouse in your vicinity or in a rural area. Observe the features of its site. Prepare a brief report based on your observations.

## 9.3 PRODUCT MIX CONSIDERATIONS

The operation and design of a warehouse depend on the product mix. Therefore, every product must be analysed in terms of demand, packaging, annual sales, etc. As a result of this analysis, one can determine the design and layout of the warehouse, warehouse space, operating controls and procedures, and materials handling equipment.

For a customer order, the product mix implies mixing products from various production or supplier warehouses for a single customer.

One example of such product mixing is shown in Figure 1:

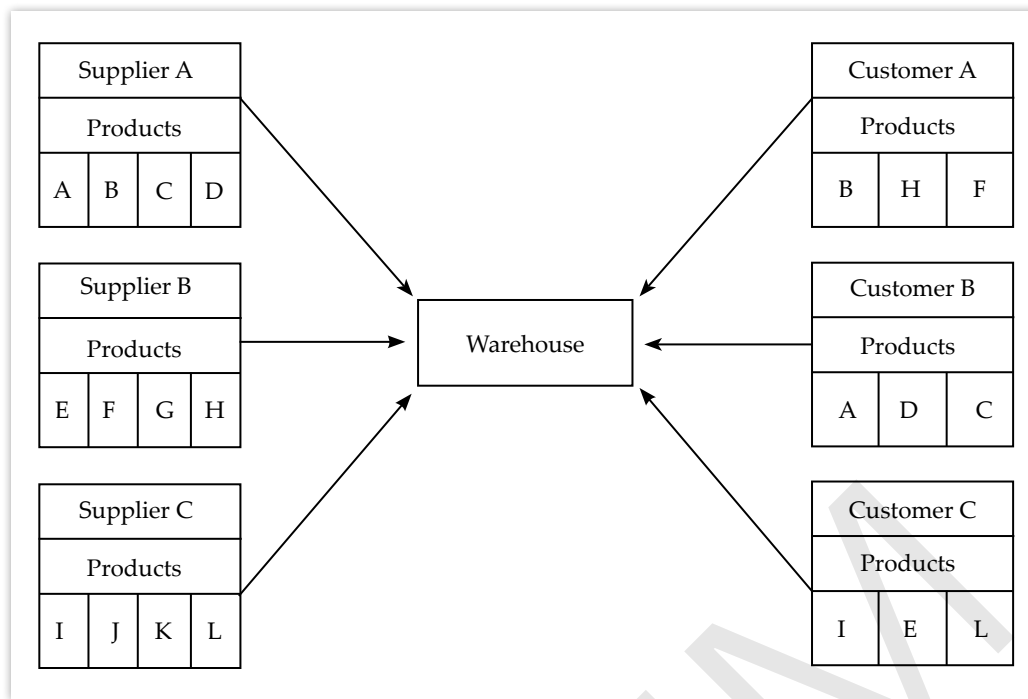

FIGURE 1: Product Mixing

The main advantage of product mixing is to reconfigure the transportation flowing from the origin to the destination, which generally results in major transportation costs. The activities of mixing are performed at a distribution centre or at the distribution level.

In a classic operation of mixing, products are loaded in trucks and then shipped from various origins to the warehouse where they are mixed. The purpose of planning these inbound transportations is to minimise transportation costs.

Inbound shipments are break-bulk when various products arrive at the mixing warehouse. They are then sorted as per the desired combination of customers. In this mixing process, inbound goods can be combined with the ones that are regularly stored at the mixing warehouse.

Mixing warehouses generally reduce the overall product storage in a logistic system while optimising transportation costs and getting various assortments needed by customers. For various product lines, a mixing warehouse can lead to more effective order fulfilment.

Generally, in a product line, various factors, such as design, colour and size, are considered. For instance, a shoe manufacturer manufactures shoes of various designs, colours and sizes. A customer or retailer generally needs a product line mixture, such as 100 pairs of blue colour sports shoes of each size and 60 pairs of green colour sprinting shoes of each size. The manufacturer may have various production plants located in different locations, each one specialising in manufacturing a particular product. These production plants can transport the required products to a mixing warehouse from where the desired orders can be fulfilled.

SELF ASSESSMENT QUESTIONS

3. The operation and design of a warehouse depend on the \_\_\_\_\_ mix.
4. The product mix does not construe mixing products from various production or supplier warehouses for a single customer. (True/False)

**9.4 WAREHOUSE DESIGN**

With the evolution of storage installations growing over time, many organisations have realised the role of warehouses in gaining an edge over competitors. Storage warehouses no longer serve the purpose of only storing products. They also support the facilities of organisations of all types and focus on offering a multitude of services.

For fulfilling this evolving role of organisations, their warehouses need to be rightly designed, so that they could compile the required information, adapt to future needs, and even fulfil their desired function.

In the next sections, we will discuss three key aspects of warehouse design, i.e., design criteria, material handling technology and storage plan.

**9.4.1 DESIGN CRITERIA**

When designing a warehouse or any distribution facility, four factors should be considered, i.e., flow, accessibility, space and throughput. These factors are applicable to all types of warehouses irrespective of the type of material that they store. Be it a spare parts store, a raw materials store for a manufacturing process or a large distribution centre, these design factors apply to all. There is no order or priority. Each factor is equally important and the objective is to get the best compromise if any conflict occurs. If any of the factors changes, other factors need to be reconsidered for analysing the impact of the change on the entire process.

These four factors are depicted in Figure 2:

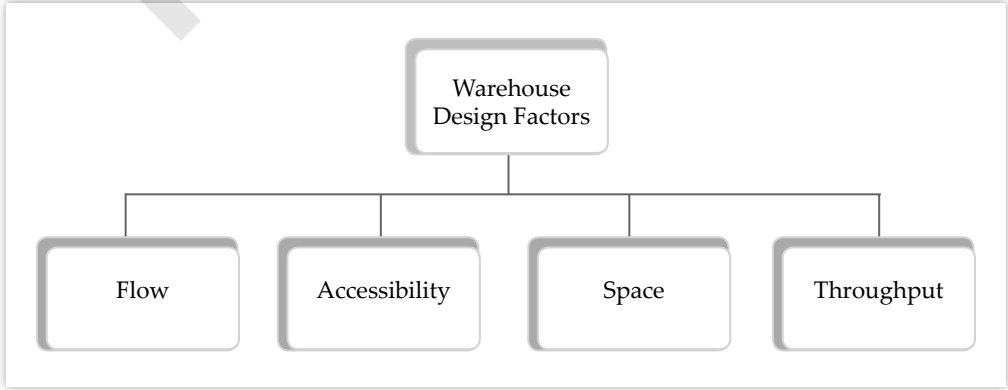

FIGURE 2: Four Warehouse Design Factors

These factors are elaborated in detail as follows:

- **Flow:** Flow means a logical sequence of warehouse operations in which all activities are placed close to each other. Flow is concerned about uninterrupted

and carefully managed movement of traffic, people and materials. Another concern is to be aware of the location and status of materials in the system and handling medium and equipment. One of the key objectives is to position and site warehouse activities for contributing to a smooth operations flow that requires a minimum amount of disruption and movement.

- **Accessibility:** Accessibility is not just limited to getting the product; it means getting the right level of pack. For example, suppose you need to access bottled water. In the case of a major Forward Market Commission (FMC) distribution centre, the accessibility will be to get and issue the product by the pallet load, generally, by using the truck loading option. Therefore, you just need to access full pallets. Since the product has a long shelf life and is very fast-moving, you need to apply the first-in, first-out rule by row to individual pallet level. On the other hand, in the case of a distributor or wholesaler, the accessibility will be to get down to the case level. Further, in the case of a convenience store stock room, it will be to get down to individual bottles. Let us take another example of pharmaceuticals, where accessibility means getting beyond individual items to a particular batch and lock number. One must achieve the requirements of accessibility levels, especially when it comes to fast-moving stock-holding and pick base areas. This should be done with no or minimum compromise to the use of space.
- **Space:** Stock processing and operational storage ought to be allotted the majority of space, whereas less space can be provided for complementary functions, such as working area, battery charging, office and empty pallets.

Table 1 shows an example of space allocation in a warehouse:

**TABLE 1: Example of Warehouse Space Allocation**

Assignable Space	Quantity	Square Feet (SF) each	Space Required	Sum Actual in SF
<b>Office Spaces</b>	–	–	–	<b>380</b>
<b>Front Office</b>	–	–	–	
Supervisor	1	120	120	
General Manager	1	180	180	
Clerical	1	80	80	
<b>Office Support Spaces</b>	–	–	–	<b>80</b>
Support/File Room	1	80	80	
<b>Tenant (subtotal)</b>	–	–	–	<b>460</b>
<b>Receiving and Shipping</b>	–	–	–	<b>4,100</b>
Staging	1	2,500	2,500	
Docks	4	400	1,600	
<b>Warehouse</b>	–	–	–	<b>35,600</b>
Forklift Parking	20	112	2240	
Dispatcher	1	120	120	
Inventory Control	2	120	240	
Bulk Storage	1	6,000	6,000	

## NOTES

Assignable Space	Quantity	Square Feet (SF) each	Space Required	Sum Actual in SF
Controlled Storage	2	1,600	3,200	
Rack Storage	1	20,800	20,800	
Package Assembly	1	1,500	1,500	
Package Disassembly	1	1,500	1,500	
<b>Tenant Suite</b>	–	–	–	<b>40,160</b>

With the presence of various storage media in the market, one can make the right use of cubic capacity of the available space which is not limited to the floor area. Most of the available equipment do not need any structural support from the building and are free-standing. Therefore, the building can be of the economical and simplest design. In addition, it allows building operational flexibility by choosing the storage media for meeting the existing stock profile and then changing it as operations evolve for meeting future needs. This is possible without any disruptive and expensive changes to the building itself. However, one must consider accessibility and flow simultaneously.

- **Throughput:** Throughput not only considers product categories going through a warehouse, but also their nature and velocity through the flow. Product nature means factors, such as dimensions and handling characteristics, that affect the way products are moved through the flow, such as bulk, hazard, security requirements, fragility and compatibility with other products. Product velocity takes care of volumes moving through the warehouse daily. If the throughput data is of high degree accuracy, it helps in the designing and layout of the warehouse to a great extent. The more accurate the data, the more is the time spent on gathering and analysing it, and the less is the risk of failure. If collecting accurate data is not possible, it is still possible to generate an acceptable solution. The best can be worked out with whatever data is available.

To summarise, while designing or creating the layout of a warehouse, factors, flow, accessibility and space need to be balanced for enabling the throughput demand with respect to the passing volume and time.

#### 9.4.2 | MATERIAL HANDLING TECHNOLOGY

The correct amalgamation of technologies can facilitate in the warehouse layout and seamless flow of products. While poorly managed and inefficient material handling operations lead to less customer satisfaction and more overhead expenses, they can also pose a significant threat to the profitability of the manufacturer. Warehouse planning can get positively impacted to a great extent with the correct use of technologies. In this section, let us take a look at the most important warehousing areas where technologies create an impact, i.e., material handling and tracking.

In the present economic climate, there is a lot of pressure on organisations for getting a quicker Return on Investment (ROI). Hence, manufacturers create new material handling equipment. There is also a need to find out faster solutions for new issues

or problems that crop up frequently. Let us discuss some of the technologies and trends that can help make this possible.

## Equipment

Material handling equipment can be defined as the mechanical equipment that is used to move, store, control and protect goods and products through the warehousing process. Various types of material handling equipment can be categorised as shown in Figure 3:

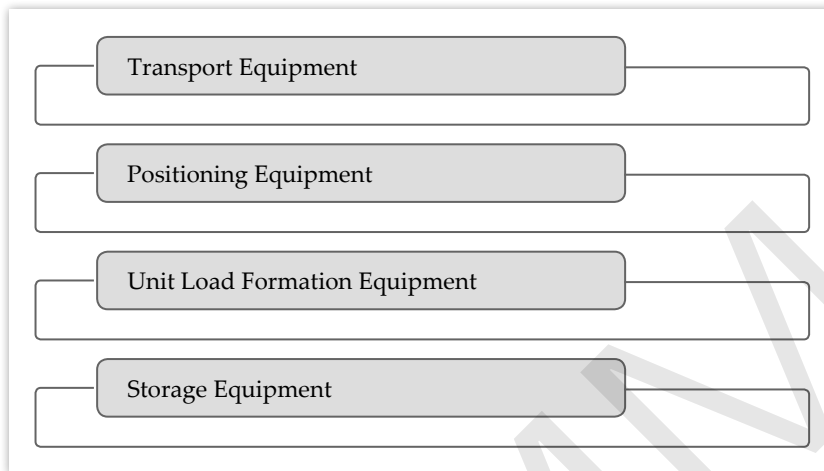

FIGURE 3: Types of Material Handling Equipment

Let us discuss these equipment types in detail:

- **Transport Equipment:** This equipment is used for moving material from one location to another like from a storage area to a loading dock. Some examples of transport equipment are conveyors, cranes and industrial trucks. Conveyors are used when materials need to be moved over a fixed path between particular points and there is a proper volume flow. A conveyor is shown in Figure 4:



FIGURE 4: Conveyor

Another type of transport equipment is a crane. It is used for transporting loads over vertical and horizontal paths within a specific area. These are used in cases

NOTES

where the conveyor's use cannot be justified and the flow is intermittent. Figure 5 shows a crane:



FIGURE 5: Crane

Another type of transport equipment are industrial trucks. These trucks do not have a license to travel on public roads and are used for moving materials over a variable path for an intermittent flow. An industrial truck is shown in Figure 6:



FIGURE 6: Industrial Truck

- **Positioning Equipment:** This equipment is used for handling materials at a single location to load/unload, feed, orient or control materials for their correct transport, handling and storage position. Some examples of this equipment are hoists, manipulators and tilt/lift/turntables. Manipulators serve as muscle multipliers as

they counterbalance a load weight for the operator to lift only a small amount of weight. A pictorial representation of a manipulator is shown in Figure 7:



FIGURE 7: Manipulator

- **Unit Load Formation Equipment:** This equipment is used for restricting materials to maintain their reliability while storing and transporting. If materials have interlocking parts or a single part, they can be shaped into a unit load without any equipment. Some examples include cartons, crates, bags, pallets and skids. Pallets are platforms that are generally made of woods and, in some cases, these are made of rubber, metal, paper or plastics. They have proper clearance below their face for enabling the fork's insertion so that they can be lifted up. A four-way pallet is represented in Figure 8:



FIGURE 8: Four-Way Pallet

- **Storage Equipment:** This equipment is used to hold or store materials for a specific time period. Their design as well as their use in the warehouse design represent an exchange between reducing handling costs and maximising space utilisation. No storage equipment is required if materials are stacked on the floor directly.

## NOTES

However, in storage, on an average, every individual item has a stack half full. To increase cube utilisation, the use of storage racks can be made for letting various stacks of multiple items to cover the space on the floor at different levels. As the number of units for each item needing storage decreases, the usage of racks starts becoming preferable to floor storage. Similarly, the depth at which items are stored has an impact on the utilisation of cubes, which is in proportion to the number of items that need to be stored.

The pallets can be stored with the use of single- and double-deep pallet racks if the number of units for each item is small. Single-deep pallet racks are shown in Figure 9:



FIGURE 9: Single-Deep Pallet Racks

Push-back and pallet flow racks are used if units per item are of the middle range. Drive-in and floor storage racks are used if units per item are large. One can either pick individual cartons from pallet loads or load in carton flow racks using the First-In, First-Out (FIFO) access. In the case of individual items, equipment, such as drawers, bin shelves and A-frames, can be utilised.

In addition to the aforementioned handling equipment, modern warehouses use some trendy handling equipment, such as:

- **High-speed sortation systems:** These systems are used in warehouses and distribution centres for sorting materials to particular storage zones and routing them to specific dock doors for the purpose of shipping. A high-speed sortation

system that provides high throughput is easy to maintain and run quietly. A high-speed sortation system is shown in Figure 10:



FIGURE 10: High-Speed Sortation System

- **Motorised roller conveyor:** A recent emerging technology in the area of conveyors is a 24-volt Motorised Roller (MDR) conveyor which has a number of additional and unique advantages over traditional belt-driven and line shaft rollers. A motorised roller conveyor is shown in Figure 11:



FIGURE 11: Motorised Roller Conveyor

### Warehouse Control Systems

Another material handling technology is the warehouse control system. Earlier, material handling control systems used to be considered as a mere collection of control and mechanical devices that move materials from one location to another within a warehouse. Generally, these used to be taken as an inconvenient requirement instead of a competitive opportunity.

However, in present times, advanced control systems offer an interface between upper-level software and material handling equipment. With this interface, it is possible to exchange information between data-driven software (such as Warehouse Management System, WMS) and material handling equipment.

More advanced level control systems are known as Warehouse Control Systems (WCS) which offer a single point interface while coordinating system interfaces and equipment. For instance, a WCS can allow integrating WMS of all equipment with real-time controls.

## NOTES

WCS can be considered as a middleware between the upper-level decision-making software (WMS) and floor automation. Floor automation includes various components, such as scales, vision systems, barcode scanners, apply systems and label printers. These also include material handling equipment, such as sorters, conveyors and Automated Guided Vehicles (AGVs). A WCS can complete operational gaps between customers and organisations, if configured and architected properly, as it provides real-time data for speeding up information, delivery and processes.

### Voice Picking

Another modern material handling technology is the voice recognition system. These systems are slowly getting popular as more and more organisations are realising their benefits. These systems offer hands-free and direct communication between a computer and the equipment operators through a headset. Operators can work with hands-on equipment while they receive computer instructions. As a result, a safer working environment is created. With the use of both the hands, the amount of work done by an operator is increased, which can result in quicker ROI and increased throughput.

### 9.4.3 | STORAGE PLAN

Designing a perfect warehouse is all about effective storage space utilisation and cost-effective handling of materials. Before creating a storage plan, the following points are significant:

- To think about building volume and not floor area
- To utilise the roof for various purposes and not just to protect from the weather
- To build the storage area upwards and not outwards as it is more economical
- To assure adequate materials movement and consider the activities involved
- Irrespective of handling large loads, palletised goods or small parts, ensure:
  - using industry-standard containers and pallets for eliminating extra handling and minimising any risks of damaging products
  - combining goods for easy storage and handling
  - reducing the number of various standard loaded weights and sizes of unit load devices for increasing flexibility
  - working in coordination with your customers for delivering standard lot sizes and unit load quantities for minimising delivery costs and handling
  - telling suppliers to utilise only the agreed-upon standard-sized units for minimising the handling and transport costs
- To use Pareto (A, B, C) analysis for categorising materials as per their attributes of handling, storage and throughput
- To select those storage systems that provide stock rotation, effective space utilisation and materials selection
- To use the current building height for deriving maximum advantage

- To take into account that storage and handling equipment are generally responsible for a small portion of the total warehouse cost
- To select the material handling equipment that offers effective storage space utilisation
- To invest in the correct type of equipment, as it helps in saving costs
- To plan flow-efficient layouts for processes, such as picking, packing, dispatch and receiving, and stock layout
- To prepare the performance specification of the building only after planning handling, and storage and internal layout
- To match the need for products with the right kind of pallet racking system
- To collect data during the design and planning process that outlines requirements
- To develop the present quantity, flow requirements and future requirements

The critical components of a building footprint related to pallet racking include overall square footage, building column layout, dock door placement, safety requirements and clear height of the building.

A sample storage plan is shown in Figure 12:

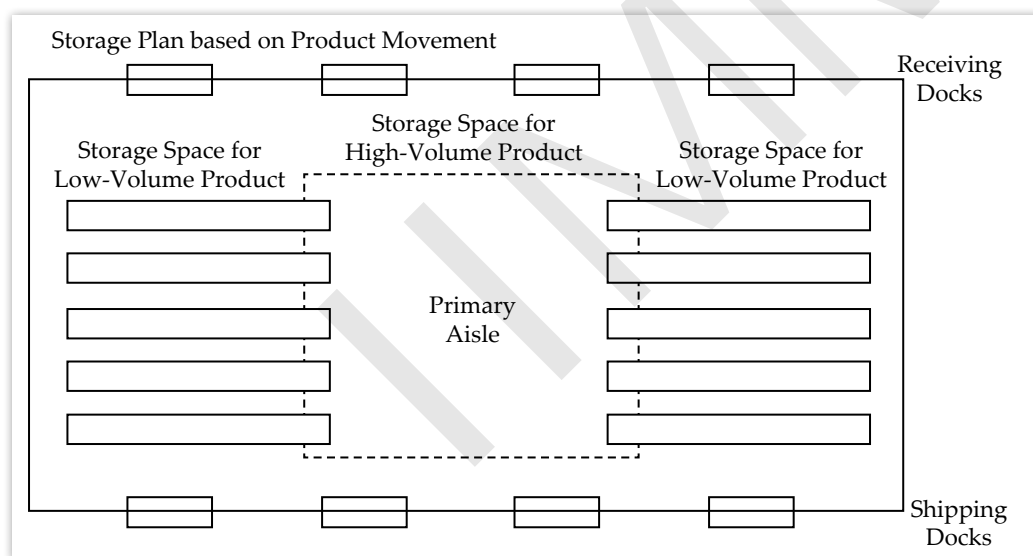

FIGURE 12: A Sample Storage Plan

#### SELF ASSESSMENT QUESTIONS

5. Storage warehouses no longer serve the purpose of only storing products. (True/False)
6. The correct mix of \_\_\_\_\_ can assist in the warehouse layout and effective flow of its products and people.

## 9.5 AISLE WIDTH DECISION

Over the past couple of decades, efforts of inventory reduction have changed the focus from storage density and warehousing to material speed and handling. While

## NOTES

this does not ignore the importance of space utilisation and warehousing, it changes the attributes of storage from high density, long term storage to selective, temporary storage.

Finding the right aisle width is an important part of the overall material handling and storage plan. Decisions on aisle width need to get the best mixture of space utilisation, productivity, safety, flexibility and equipment costs for a particular application. Key restrictions to the width of aisles are the attributes of loads and lift trucks being used. Load attributes cannot be changed significantly. Therefore, aisle width decisions are actually material handling equipment decisions.

In racked storage, lift trucks utilised for handling unit loads are categorised by their aisle widths. These are shown in Figure 13:

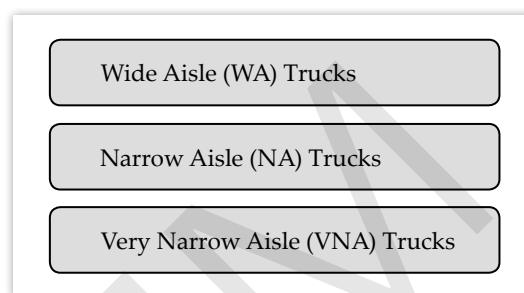

FIGURE 13: Lift Trucks Categorised by Aisle Types

These are discussed as follows:

- **WA trucks:** Typical counter-balanced lift trucks are WA trucks. These have become synonymous with 'forklift' and usually function in aisles that have width greater than 11', which is the standard size to handle 48" deep loads.
- **NA trucks:** They function in aisles of 8' to 10' which is the major area of double-deep and stand-up reach trucks.
- **VNA trucks:** They usually function in aisles of less than 6'. In most cases, they utilise guidance systems, such as optical, wire and rail for travelling within aisles.

Various other designs are also available that operate in narrow aisles bridging gaps among narrow, very narrow and wide aisles. Such designs include stand-up straddle, walkie counter-balanced stacker, stand-up counterbalanced, walkie reach stackers and walkie straddle stackers. Out of these, the most affordable ones are walkie designs that offer narrow aisle function for even the smallest storage areas and warehouses.

When taking aisle width decisions, the most important factor are space savings that are affected by many other factors. These include load size, rack height, load weight and facility's structure and dimensions. For example, for a standard 40" x 48" load with 1500 lbs. of weight, you can store 40% to 50% more if you use VNA and 20% to 25% more if you use NA. Calculations might get more complicated if one needs to use narrow aisles and double-deep storage.

Aisle width decisions are not easy to make. One needs to work closely with the supplier of the material handling equipment to get extra help needed to use the best methods as per the business needs.

**SELF ASSESSMENT QUESTIONS****NOTES**

7. Finding the right \_\_\_\_\_ width is an important part of the overall material handling and storage plan.
8. Aisle width decisions are easy to make. (True/False)
9. Match the following:

List 1	List 2
1. Transport equipment	a. offer hands-free and direct communication between a computer and the equipment operators through a headset
2. Positioning equipment	b. incurred in every warehouse, irrespective of the throughput and size of the warehouse
3. Voice recognition system	c. dependent on whether the inventory is placed in a single warehouse or distributed into many
4. Labour costs	d. used for moving material from one location to another like from a storage area to a loading dock
5. Facility costs	e. used for handling materials at a single location to load/unload, feed, orient or control materials

a. 1-d, 2-e, 3-a, 4-b, 5-c

b. 1-c, 2-d, 3-a, 4-e, 5-b

c. 1-a, 2-c, 3-b, 4-d, 5-e

d. 1-e, 2-c, 3-a, 4-b, 5-d

**9.6 SUMMARY**

- An efficient warehouse location and its design are the bases of an effective supply chain.
- A warehouse should be located at such a place and should be designed in such a way that it can serve your customers efficiently and in time.
- Organisations meticulously plan for warehouse location, design and size as these factors cannot be altered once the warehouse is set up.
- To maintain a healthy or seamless flow of goods, it is prudent to set up a warehouse at the place where goods transit time is minimum.
- The decision to select a warehouse site has a substantial effect on transportation types, the customer service level and the markets that can be served.
- The process of warehouse site selection is complex involving both qualitative and quantitative criteria; major changes in an organisation's operational environment further enhance its complexity.
- Organisations need to decide whether they require an individual warehouse for serving their needs across the nation, need to replace an existing facility, or need to complement the current network by installing a new facility.
- Good designers who consider warehouse and service locations of competitors end up setting up a warehouse that provides better sales and service levels.

## NOTES

- Once an organisation has decided on a general location for the site of its warehouse, it must determine whether it should be a rural setting or an urban one.
- The operation and design of a warehouse depend upon the product mix. Every product must be analysed in terms of demand, packaging, annual sales, etc.
- In a classic operation of mixing, products are loaded in trucks and then shipped from various origins to the warehouse where they are mixed.
- Mixing warehouses generally reduce the overall product storage in a logistic system while optimising transportation costs and getting various assortments needed by customers.
- When designing a warehouse or any distribution facility, four factors should be considered, i.e., flow, accessibility, space and throughput. These factors are applicable to all types of warehouses, irrespective of the type of material they store.
- Flow means a logical sequence of warehouse operations in which all activities are placed close to each other. Flow is concerned about uninterrupted and carefully managed movement of traffic, people and material.
- The maximum space should be allocated for the purpose of stock processing and operational storage while the minimum space should be allocated to related functions, such as working area, battery charging, office and empty pallets.
- In the present economic climate, there is a lot of pressure on organisations for getting a quicker Return on Investment (ROI); hence, manufacturers create new material handling equipment.
- Material handling equipment can be defined as the mechanical equipment that is used to move, store, control and protect goods and products through the warehousing process.
- Push-back and pallet flow racks are used if units per item are of the middle range, and drive-in and floor storage racks are used if units per item are large.
- One can either pick individual cartons from pallet loads or load in carton flow racks using the First-In, First-Out (FIFO) access.
- Decisions on aisle width need to get the best mixture of space utilisation, productivity, safety, flexibility and equipment costs for a particular application.
- Key restrictions to the width of aisles are the attributes of loads and lift trucks being used.

## 9.7 KEY WORDS

- **Inventory costs:** Inventory costs increase with an increase in the distribution network. Organisations with large distribution networks require additional inventory in their warehouses to handle out-of-stock inventory conditions.
- **Inbound and outbound transportation costs:** These costs decrease with an increase in the network as the more the number of warehouses, the higher is the role of inbound shipping which is more effective than the outbound one.
- **Transport Equipment:** This equipment is used for moving material from one location to another like from a storage area to a loading dock.

- **High-speed sortation systems:** These systems are used in warehouses and distribution centres for sorting materials to particular storage zones and routing them to specific dock doors for the purpose of shipping.
- **Manipulators:** They serve as muscle multipliers as they counterbalance a load weight for the operator to lift only a small amount of weight.

## 9.8 CASE STUDY: BUILDING AND CONSTRUCTION MATERIAL DISTRIBUTOR WAREHOUSE REDESIGNING

A leading building and construction material distributor in North America was expanding so fast that its inventory went beyond the current capacity of its warehouse. There was a need to optimise the design of the warehouse in a practical and cost-effective way, so that it may support its operations for the next couple of years. The warehouse was also needed to be optimised to increase its productivity and, hence, improve the functioning of the other 17 distribution centres of the organisation in the region.

For achieving this objective, the organisation hired a third-party vendor. The vendor first analysed the current operational needs of the warehouse. Then, it collected the required data and coordinated with the project team of the organisation for determining the ideal inventory level and the plan for achieving it with the use of pallet quantities.

The vendor suggested to floor-stack the crates and pallets in the warehouse, which resulted in preventing significant investment required for pallet racks. In addition, it recommended setting up a forward pick area with the use of some selective pallet racks. The vendor made this recommendation after analysing the transaction and order log.

As the floor-stacked pallets were suggested for improving warehouse productivity, the vendor designed a location scheme that utilised location labels and striped lanes. Considering the detailed quantitative analysis of the future inventory, a layout was created that positioned pallets into every location by pallet quantity and product family. The vendor also redesigned the shipping and receiving area with the recommendation to relocate the break room close to the facility's front offices.

As a result of implementing the warehouse redesigning suggestions of the vendor, the building and construction material distributor achieved the projected Return on Investment (ROI) of 19 months. The order fulfilment productivity increased to 56% more than the forecast. Moreover, the pallet capacity increased to 33% more than what was forecasted.

Source: *trantexinc.com*

### QUESTIONS

1. Why was there a need to optimise the design of the warehouse?  
(**Hint:** The inventory went beyond the current capacity, increase productivity, etc.)
2. What did the vendor plan and coordinate with the organisation's project team?  
(**Hint:** Deliberated about ideal inventory level and the use of pallet quantities)

## NOTES

3. What did the vendor suggest to the project team?  
(**Hint:** Put forth floor-stacked pallets and redesigned floor-stacked pallets.)
4. What were the various results of warehouse redesigning?  
(**Hint:** Order fulfilment productivity increased to 56%, achieved the projected ROI, etc.)

**9.9 EXERCISE**

1. Discuss how to perform site analysis for a warehouse.
2. What are the four factors that should be considered when designing a warehouse or any distribution facility? Explain them.
3. Explain the different material handling technologies.
4. List key points to be considered while creating a storage plan.
5. What are the important budget costs that need to be considered while designing a warehouse?

**9.10 ANSWERS FOR SELF ASSESSMENT QUESTIONS**

Topic	Q. No.	Answer
Site Analysis	1.	True
	2.	warehouse
Product Mix Considerations	3.	product
	4.	False
Warehouse Design	5.	True
	6.	technologies
Aisle Width Decision	7.	aisle
	8.	False
	9.	a. 1-d, 2-e, 3-a, 4-b, 5-c

**9.11 SUGGESTED BOOKS AND E-REFERENCES****SUGGESTED BOOKS**

- Richards, G. (2017). *Warehouse Management*.
- Stephens, M. (2018). *Manufacturing Facilities design & Material Handling*.

**E-REFERENCES**

- Trunick, P. (2019). *How to design a regional warehouse*. [online] Material Handling and Logistics (MHL News). Available at: <https://www.mhlnews.com/transportation-and-distribution/how-design-regional-warehouse> [Accessed 5 Dec. 2019].
- Logisticsbureau.com. (2019). *Warehouse Design: What are the Key Factors to Consider?*. [online] Available at: <https://www.logisticsbureau.com/warehouse-design-key-factors-to-consider/> [Accessed 5 Dec. 2019].

# Warehouse Activities and Equipment

## Table of Contents

---

- 10.1 Introduction**
- 10.2 Warehousing Activities**
  - 10.2.1 Product Movement
  - 10.2.2 Product Storage
  - 10.2.3 Information Transfer
    - Self Assessment Questions
- 10.3 Goods Pickers**
  - 10.3.1 Types of Automated Picking
  - 10.3.2 Examples of Automated Picking
    - Self Assessment Questions
- 10.4 Handling Equipment**
  - 10.4.1 Storage Equipment
    - Self Assessment Questions
- 10.5 Summary**
- 10.6 Key Words**
- 10.7 Case Study**
- 10.8 Exercise**
- 10.9 Answers for Self Assessment Questions**
- 10.10 Suggested Books and e-References**

**LEARNING OBJECTIVES**

*After studying this chapter, you will be able to:*

- Explain the concept of product movement in a warehouse
- Describe product storage in a warehouse
- Discuss how to perform information transfer in a warehouse
- Elaborate automated picking
- Explain various types of storage equipment

**10.1 INTRODUCTION**

In the previous chapter, you studied how to take the warehouse location and design decisions. You learned how to perform site analysis, consider product mixing and design a warehouse. In addition, you understood various material handling technologies and key points to consider while creating a storage plan along with aisle width decisions.

Once a warehouse is built, it is important to have seamless warehouse activities using quality material handling equipment. Warehouse activities and operations form an integral part of the organisation's business strategy. If these operations are effective, it is ensured that the organisation receives and ships stock in time for the purpose of manufacturing or replenishment on store shelves.

In a warehouse, storage equipment is used to hold or buffer materials for a period of time. There are various types of storage equipment that can be used to store materials.

In this chapter, you will learn about various warehouse activities, such as product movement, product storage and information transfer. You will also go through the types and examples of automated picking. Later, the chapter will explain the features of various types of storage equipment.

**10.2 WAREHOUSING ACTIVITIES**

Warehousing has an important role to play in the logistics system of organisations. In a warehouse, a number of varied activities are performed to ensure adequate fulfilment of consumer needs. In combination with other logistics activities, it provides the required customer service levels. Though there are multiple warehousing activities, most of them can be categorised as shown in Figure 1:

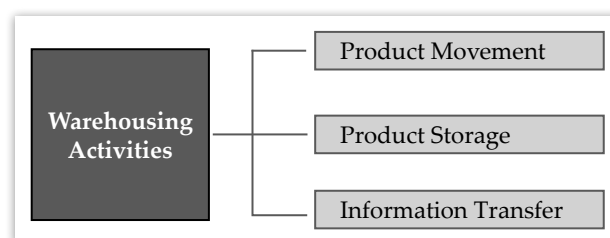

FIGURE 1: Warehousing Activities

## 10.2.1 | PRODUCT MOVEMENT

Product movement can be deemed as shifting goods while undertaking various warehousing activities in which goods are moved from one place to another. The four main activities involved in the product movement are depicted in Figure 2:

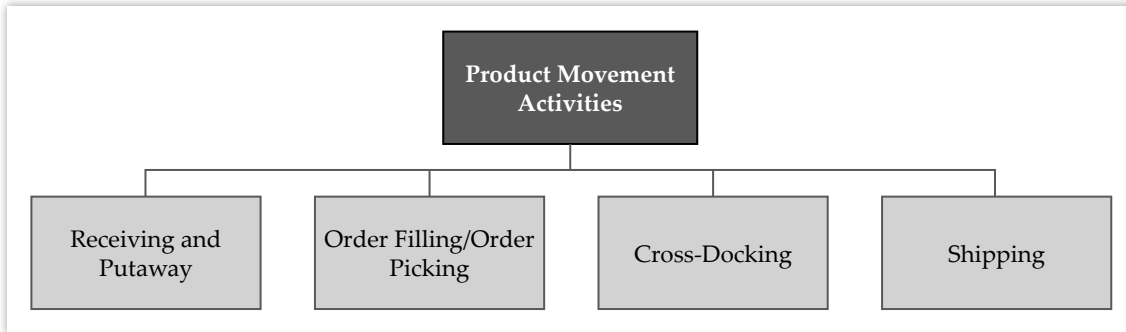

FIGURE 2: Product Movement Activities

These are elaborated as follows:

- **Receiving and putaway:** It includes unloading goods or products from the transportation equipment, performing a count and standards verification as per records, checking the goods for any damage and updating inventory records. The receiving process subsumes to classify and sort the obtained goods. Moreover, prior to storing them in the warehouse, the received shipments are prepacked into smaller ones. This entire activity ends with pass away tasks that involve moving the goods physically to storage areas, places for outbound shipments and areas of specialised services, such as consolidation areas.
- **Order filling/Order picking:** This is the basic activity that includes tasks to identify and retrieve products from their respective storage areas as per the customer orders received. It also involves gathering, regrouping and packing the desired products into the required mixtures as per customer orders. Some other tasks may include generating delivery lists and packing slips. Performing order picking activities consumes a lot of time and labour.
- **Cross-docking:** This activity generally involves getting products or goods from one source and consolidating them with others that are from other sources and have the same destination, and finally sending the consolidated lot to the customer quickly. A pure cross-docking activity only includes organising the materials transfer from the inbound receiving dock to the outbound one while avoiding other activities, such as storing, putting away and order filling. However, in practice, there can be a delay of one to three days and the required products might be stored in a warehouse.
- **Shipping:** In this activity, several tasks are performed, such as moving and loading assembled orders physically on some transport carriers, inspecting the sequence and the content of those orders, and keeping the inventory records updated. Some other tasks include classifying and packing products for explicit customers and packing products to avoid any damage.

### 10.2.2 | PRODUCT STORAGE

The product storage activity refers to the accumulation of inventory for a time period. In warehouses, inventory storage may happen for different lengths of time and in different storage locations, depending on the purpose of storage. There are four primary functions in storage that impact warehouse design. They are holding, consolidation, mixing and break-bulk.

Warehouses are typically designed to complete one or more of these functions. The structure and layout of a warehouse depend on the importance that is given to perform these functions.

Product storage can be of two types, i.e., long-term or semi-permanent storage, and short-term or temporary storage. Long-term or semi-permanent storage involves storing products more than what the demand is. For example, arm and ammunition are stored for possible use during a war. In contrast to long-term storage, temporary storage involves storing products that are required for basic inventory replenishment and its amount is determined by the extent of changeability in demand and lead time. For example, Coca-Cola bottles are stored for delivery the very next day. The logistics system design also has an impact on the extent of inventory to be stored. Its main emphasis is product movement. Pure cross-docking uses temporary product storage.

### 10.2.3 | INFORMATION TRANSFER

To administer warehouse operations, managers need to have timely and precise information. Therefore, importance is given to the information transfer activity. This activity works simultaneously with the other two activities that are product movement and product storage. With the help of this activity, a warehouse manager can keep track of products' locations, throughput and inventory levels and shipments (both inbound and outbound). A successful warehousing operation is the result of this information flow in addition to data on personnel and customers, space utilisation and other relevant parameters. Nowadays, organisations realise the importance of effective information transfer. Therefore, they are continuously improving their means, speed and accuracy of information transfer by using modern and computerised processes, such as pre-packing bar codes, Electronic Data Interchange (EDI) systems, and the Internet.

#### SELF ASSESSMENT QUESTIONS

1. \_\_\_\_\_ can be deemed as shifting goods while undertaking various warehousing activities in which goods are moved from one place to another.
2. To administer warehouse operations, managers should not be concerned about on-time and precise information. (True/False)

## 10.3 | GOODS PICKERS

Goods picking or order picking is a term used to define an activity under which a number of goods are collected from a warehouse in order to fulfil multiple independent orders received from customers. Medium- and small-size organisations fulfilling and

shipping customer orders consume more number of resources as compared to other fulfilment operations. Even if it is only daily operations of fulfilling customer orders and tracking items in the warehouse for shipping, the picking process is already in place, whether a person is aware of it or not.

However, the key question is about the ease of using that process as the business grows and about its accuracy that impacts customers. The concern is if the process that works accurately at present, for instance, thirty orders, will it work when there are a hundred orders per day?

The picking process plays a major role in terms of impact on customers and resource utilisation. Therefore, it is necessary to optimise the picking process, which results in increased productivity, reduced costs and remaining competitive.

Some other benefits of optimising the picking process are:

- It helps in organising orders and items. Many available techniques for organising products are based on the way organisations prioritise the significance of speed, dimension, accuracy, product size and various other factors.
- It helps reduce the load on workers and their morale is improved. If the picking route is optimised, it results in less wear and tear, and fewer footsteps for employees.
- It facilitates faster cycle time and order completion. More items are picked per hour, which implies higher turns and more waves in each shift.
- It aids in minimising the travel time of pickers. In case of a well-organised picking process, even the most basic warehouse software can help in minimising the picking time and optimising the process for getting products from the shelf to the packing station.
- It enhances productivity as the volume and speed of picking are increased, which results in increased velocity per square foot. Generally, the major decision of moving to bigger warehouses and redesigning the existing ones can be eliminated if the changes required for maximising productivity are deployed.
- It enables warehouses to increase the accuracy of picking. There is a chance of losing customers if organisations are not measuring the accuracy in the way the Information Technology (IT) department measures the network downtime.
- It facilitates faster and easier training processes.
- It helps in increasing customer satisfaction which is perhaps the most important benefit. Picking accuracy and designing a process to increase productivity go hand-in-hand by creating a team culture in which employees know the importance of their work for customers.
- It provides a much needed competitive edge. Moreover, processes are improved, shipments are faster, handling costs per item are less, wastes are less and the turnover is increased.

The picking process can be completed using a variety of methods. While some of them are commonly known to all industry types, the others are customised ones that are developed by different organisations as per their requirements.

## NOTES

Among various terms one may encounter, some common ones are carton flow rack, cluster pick and pick to light. Organisations that have distribution centres and warehouses develop a tendency to improve their productivity while being preoccupied with reducing costs. Yearly, more investments are done for improving technology, hence optimising performance to fulfil the specific organisation or industry needs. It is possible by increasing automation for order picking or using a mix of various methods of order picking.

There are various types of order picking methods. The basic order picking methods are depicted in Figure 3:

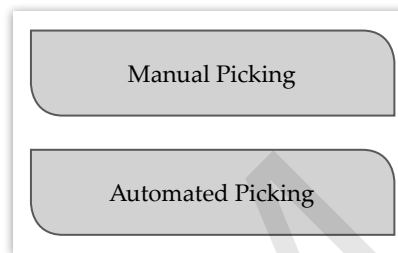

FIGURE 3: Order Picking Methods

Meeting the desired objective of optimal performance in a warehouse depends on selecting the right kind of order picking method. While in this section, we will mainly focus on automated picking in detail, let's get an overview of manual picking as well.

Manual picking methods include the process of picking merchandise, items or products from a warehouse without taking any help of an application or any other equipment that automates a few or all activities. There are several methods to perform manual picking, such as picker to part or piece picking method, zone picking method, wave picking method and pick-to-box method. This type of picking makes sense when organisations need to cater to customers' needs. Organisations that sell fast-moving goods having high Stock Keeping Unit (SKU) counts understand their benefits as this method does not require much investment in equipment and technology.

Automated picking methods are those that include placing, picking and getting materials or items from warehouses with the use of computerised systems that are integrated with various applications and equipment.

Some advantages associated with automated picking are:

- It increases efficiency and productivity as the method reduces dependency on manpower resources and labour.
- It improves safety as computer-controlled equipment performs most activities, such as replenishment, unloading and picking.
- It helps reduce errors as most of the automated systems are programmed on the basis of daily operations and do what the computer instructs.
- It ensures effective use of facility space and time as machines perform tasks faster and facilitate an increase in the density of products.

- It reduces labour costs as automated picking reduces dependency on human labour.
- It improves product quality as products are handled with extreme care by machines.

Since this method offers a variety of benefits, various corporations and organisations use it, such as manufacturing, retail, food and beverage.

### 10.3.1 | TYPES OF AUTOMATED PICKING

In the present business environment, organisations are continuously seeking out justification to allocate more funds to use more automation, especially when it comes to the picking process where labour costs are high. Automated picking systems depend on the design purpose and the type of industry. These systems vary depending on the types of operations.

In automated picking, material movement takes place in part or completely by robotics or machines. The common types of automated picking systems are depicted in Figure 4:

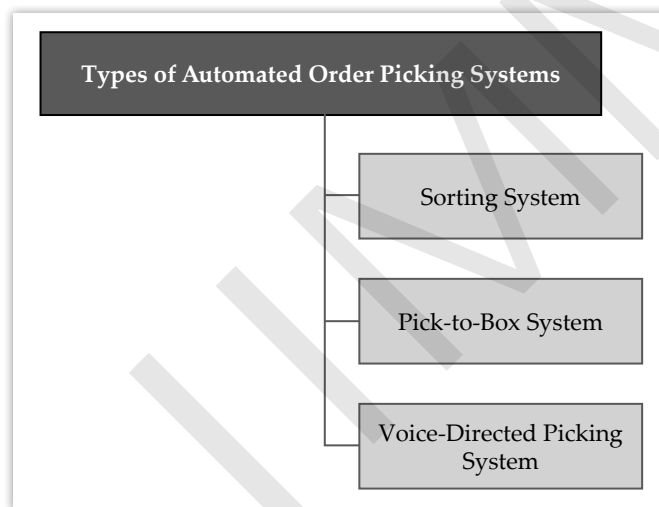

FIGURE 4: Types of Automated Order Picking Systems

These are discussed as below:

- **Sorting system:** A sorting system is also known as a conveyor system. Actually, it uses the conveyor system and employees or staff need not go to the location where products are placed. The orders are brought automatically to the staff. This method requires a picking area, a storage area, picking area replenishment and a sorter. It utilises an automatic material handling system that includes various conveyors and multiple sorting devices. In the storage area, items are placed on a conveyor and subsequently sorted as per specific orders. In the picking area, the operator collects the sorted orders to process and complete customer orders. This method proves effective as the operator does not require to spend time in collecting individual items.
- **Pick-to-box system:** In a pick-to-box system, multiple picking stations are combined by a conveyor system. This system does not require the warehouse staff

## NOTES

to move much. The staff only needs to shift from one order station to another for completing the order. It is similar to the sorting method as it also utilises picking area, storage area, picking area replenishment and a sorter. There is a need to organise the picking area for connecting multiple picking zones using a conveyor system. For customer orders, the operator fills the box with the required products. After this, the box moves to the picking zone. Once the customer order is complete it is ready to be shipped to the ultimate destination. This method is quite efficient as the operator need not spend much time in gathering individual items. However, the initial setup cost can sometimes negate other benefits.

- **Voice-directed picking system:** In this picking system, a computerised voice system provides orders to workers on what needs to be picked, from where to pick and what quantity needs to be picked. This method proves to be the most efficient one as it allows workers to use a speech recognition system and voice direction software through headsets that are equipped to a wearable computer small in size. These systems instruct workers what to do and where to go with the use of verbal commands. Workers confirm the completion of their tasks by saying some predefined commands and reading confirmation codes that are available and printed on products or locations. As a result, the picking accuracy is maintained.

### 10.3.2 | EXAMPLES OF AUTOMATED PICKING

Some examples of automated picking systems are discussed as follows:

- **Zone Picking System (ZPS):** ZPS or zone picking system is the one in which every employee or order picker is assigned a particular zone or area. The person is responsible only to pick the items that are redesigned in that area whenever there is a customer order. The container or box moves through various zones with the use of a conveyor belt. It generally uses flow racks or a similar kind of shelving where picked items can be easily replenished from a different area without any interruption to the picking floor activity.
- **Automated case picking system:** This system uses an automated crane for picking up voluminous and heavy cases. It can lift, transport, store, select and replenish big cases for meeting customer demands. Similar to the pallet picking system, this system also allows the use of much higher shelving, so that workers need not put them on their own on an aisle picker or in rafters and get physical injuries. Due to higher shelving, space utilisation is high. It allows warehouse managers to create or rent out space for maximising the system impact. This method is generally used for the replenishment purpose even if picking is done manually by retrieving cases overnight for the replenishment of picking areas.
- **Pallet picking system:** This system combines the use of automated cranes, pallet conveyors and the sorting system to make sure that the product management and standard capacity is maintained. Automation can provide increased safety with less direct interactions for the entire facility area and forklifts to the organisations that majorly deal with retrieving and shipping palletised cases and products.

- **Batch picking or multi-order picking:** In this process, several product demands from orders are combined into one picking instruction. This results in great efficiency as the tedious manual order picking process is eliminated. One can automate the manual picking method and wave picking method to some extent.

#### SELF ASSESSMENT QUESTIONS

3. \_\_\_\_\_ methods are those that include placing, picking and getting materials or items from warehouses with the use of computerised systems.
4. Zone Picking System is the one in which every employee or order picker is assigned a particular zone or area. (True/False)

#### ACTIVITY

Search for organisations that use automated order picking systems. Look for the types of automated picking systems used. Find out how the system is able to increase efficiency, reduce human efforts and ensure safety at work.

## 10.4 HANDLING EQUIPMENT

Material handling equipment can be defined as the mechanical equipment that is used to move, store, control and protect either goods or products through the warehousing process. There are four types of material handling equipment, i.e., transport equipment, positioning equipment, unit load formation equipment and storage equipment.

### 10.4.1 STORAGE EQUIPMENT

You have learned in the previous chapter that storage equipment is used to hold or store materials for a specific time period. Their designs along with their use in the design of the warehouse represent an exchange between reducing handling costs and maximising space utilisation.

The main reason to store products in a manufacturing warehouse is to allow other production elements to function more effectively on the per unit basis. This, in turn, will cover the fixed costs for number of products. For example, storing in-progress elements allows batch production which minimises the setup costs on the per unit basis, and storing a truckload of a product in a warehouse minimises the shipping costs on the per unit basis.

Some other reasons for storing products are:

- For the processing of products, such as wine, where storage is a processing option as products undergo a required change in storage
- For bridging time gaps which enables products to be available as and when required; for example, storing spare machine parts
- For securing nuclear products

## NOTES

Common types of storage equipment are listed in Figure 5:

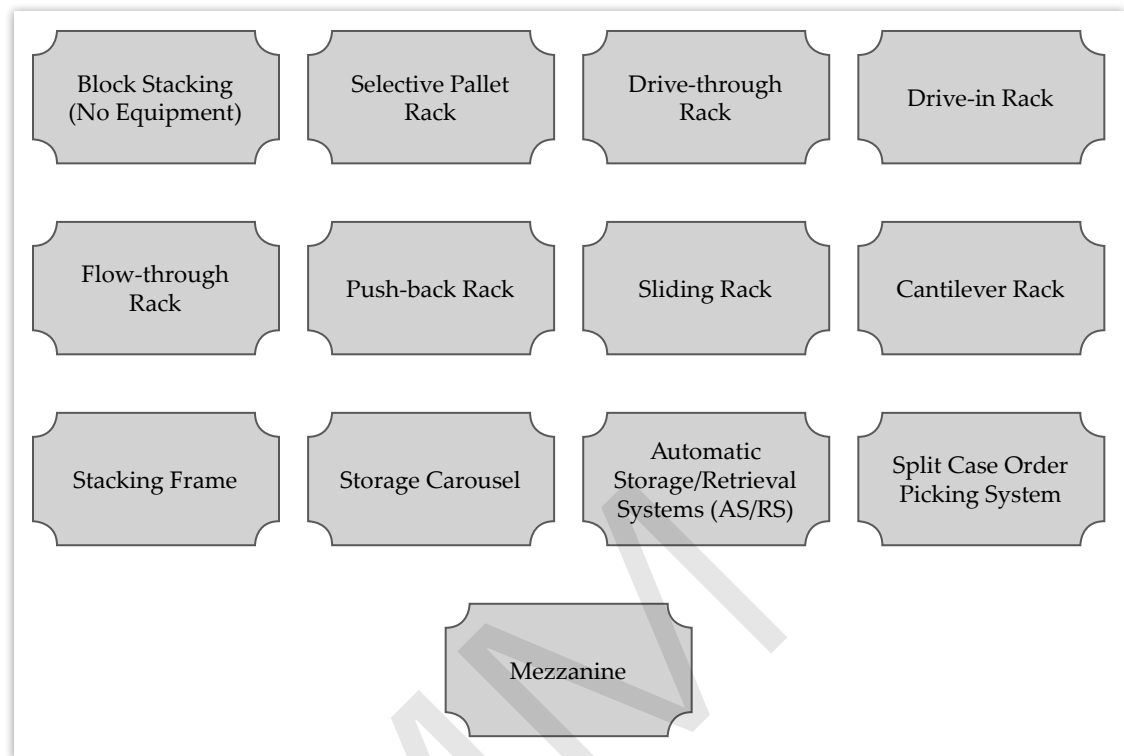

FIGURE 5: Common Types of Storage Equipment

These types are explained as follows:

### Block Stacking (No Equipment)

This is the least expensive storage type and is most commonly used for bulk storage. It includes the utilisation of cubes and does not require any storage medium; however, it limits material accessibility. In block-stacking, material accessibility is low because one can only access the top of the front stack. The loads placed at the bottom of a stack do not need any support. Storage racks are utilised when material accessibility or support is needed.

### Selective Pallet Rack

This is the most popular type of a storage rack. In this type, pallets are supported by load-supporting beams. One can use decking and special attachments with racks to support other unit load types apart from pallets, such as drums, coils and skids. Selective pallet racks are utilised for mainly three types of storage, which are:

- **Standard:** It is defined as a single deep storage with the use of a counter-balanced lift truck.
- **Narrow aisle:** It is defined as a storage with the use of a narrow aisle lift truck.
- **Deep reach:** It is defined as storage that is greater than single deep storage, usually double-deep storage.

A selective pallet rack is shown in Figure 6:

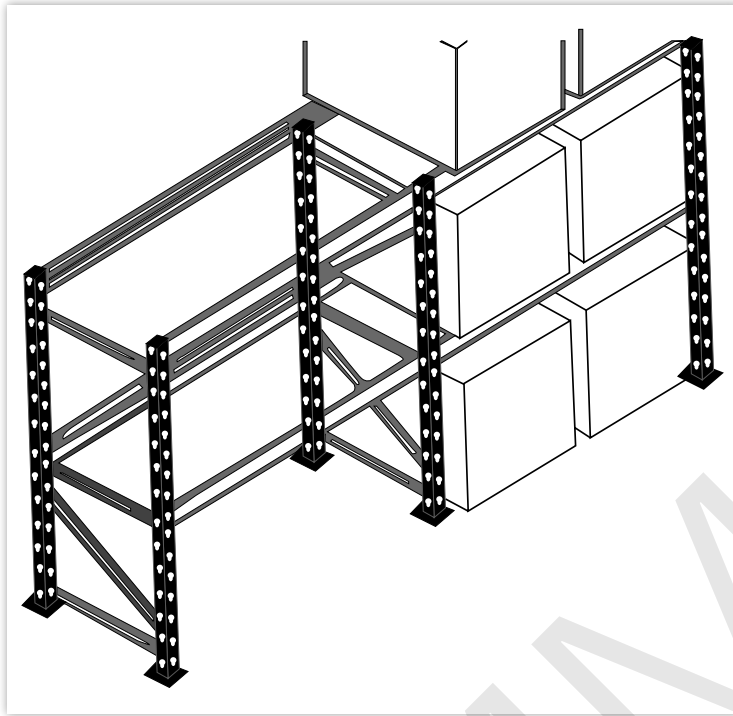

FIGURE 6: Selective Pallet Rack

### Drive-through Rack

In drive-through racks, loads are sustained by rails with upright beams attached to them. The upright beams drive lift trucks. These racks need similar width loads. They open at both their ends and, thus, one can access materials from both the ends using the First-In-First-Out (FIFO) method.

A drive-through rack is shown in Figure 7:

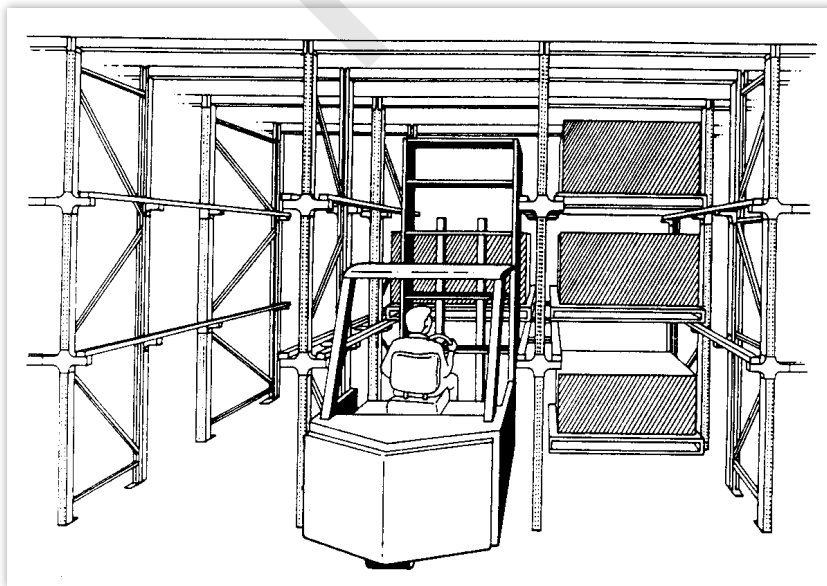

FIGURE 7: Drive-Through Rack

NOTES

**Drive-in Rack**

These racks are similar to drive-through racks except the difference that they are closed at one end, which allows materials' access from just one end. Materials in these racks are accessed by using the Last-In-First-Out (LIFO) method.

A drive-in rack is shown in Figure 8:

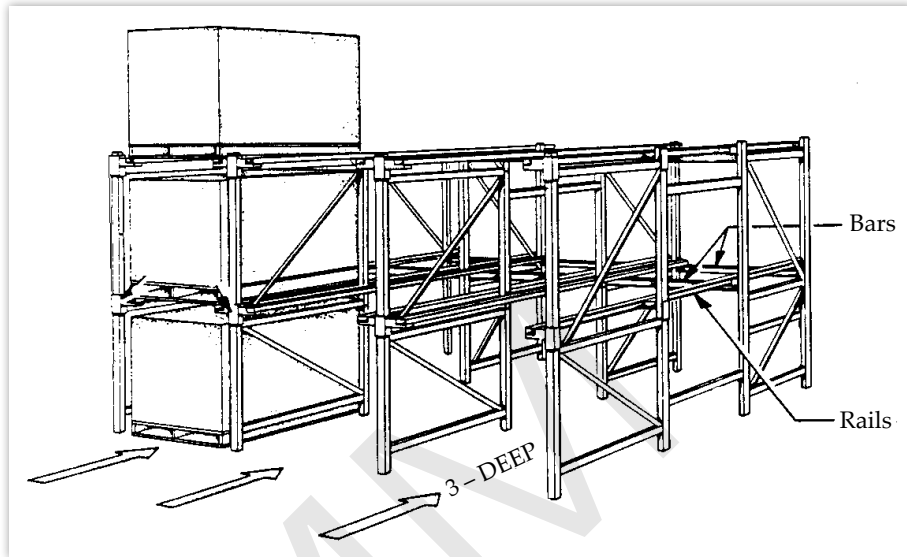

FIGURE 8: Drive-in Rack

**Flow-through Rack**

In these racks, loads are supported on an inclination for enabling gravity-based load movement within the rack, for example, through a gravity roller conveyor. Materials are loaded at the higher end and then unloaded at the lower following the FIFO method.

A flow-through rack is depicted in Figure 9:

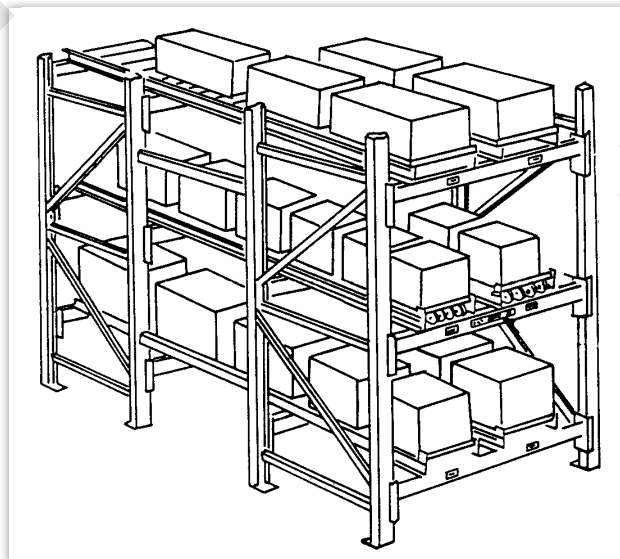

FIGURE 9: Flow-Through Rack

### Push-back Rack

These racks are the same as flow-back racks. The difference is that materials are loaded and unloaded at the lower end, which is closed at the higher end to enable LIFO.

A push-back rack is shown in Figure 10:

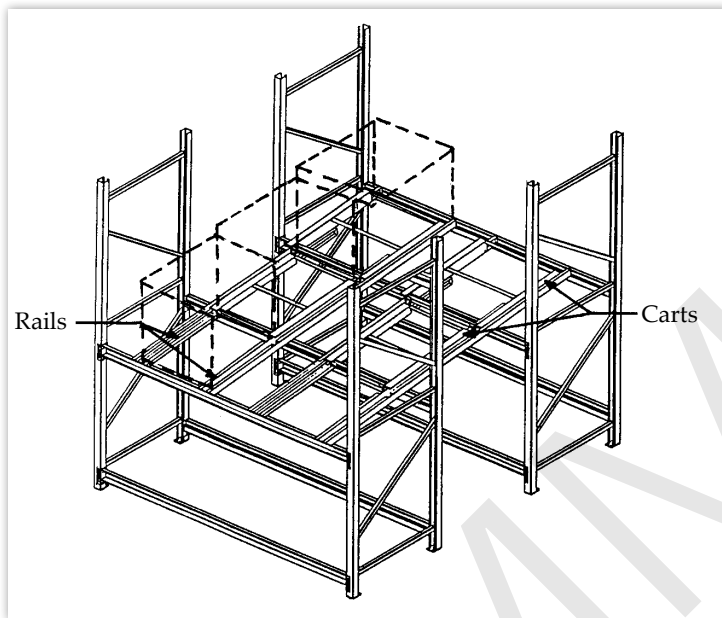

FIGURE 10: Push-Back Rack

### Sliding Rack

In these racks, just one mobile aisle allows accessing many rows of racks. One can change the aisle location easily by sliding the rack rows along guide rails on the floor.

A sliding rack is shown in Figure 11:

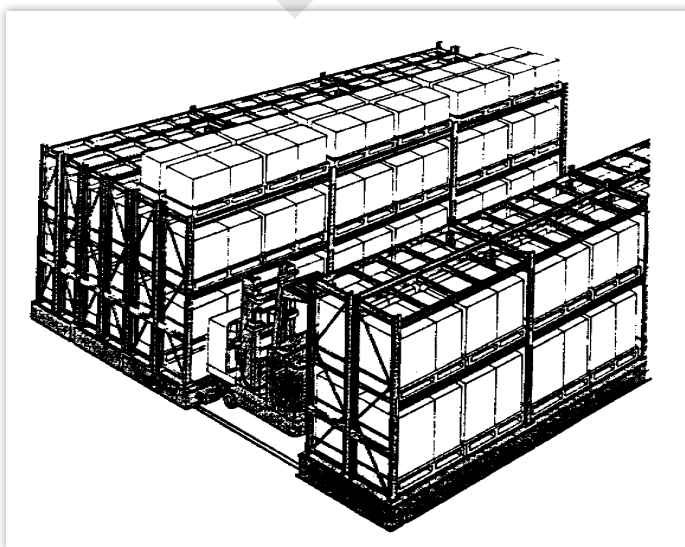

FIGURE 11: Sliding Rack

NOTES

### Cantilever Rack

In these racks, cantilever arms are used to support loads. These racks are used for storing long loads, such as pipes and bars. These are similar to pallet racks. However, the only difference is that the front supporting and front upright beams are removed.

A cantilever rack is shown in Figure 12:

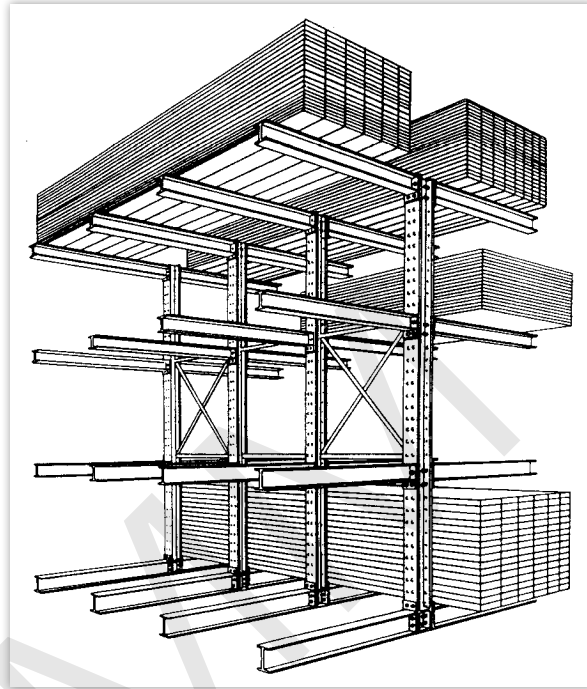

FIGURE 12: Cantilever Rack

### Stacking Frame

Stacking frames are interlocking units that allow load stacking to avoid crushing. When not in use, one can disassemble them and store them compactly. An organisation can use pallet frames for multilevel block stacking.

Stacking frame is shown in Figure 13:

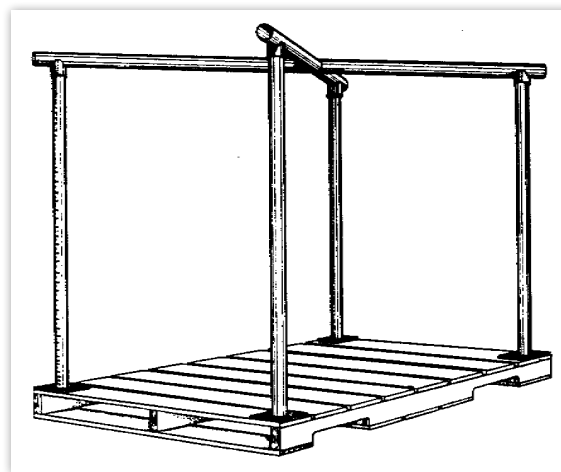

FIGURE 13: Stacking Frame

## Storage Carousel

This includes a set of horizontal and vertical storage bins or baskets that revolve. The storage medium and materials move to the operator for the purpose of the end of aisle picking. Either clockwise or anti-clockwise, every carousel level is capable of rotating independently. Storage carousels can be controlled by using automated controlled systems or manually activated push buttons. They are similar to trolley conveyors with storage baskets.

A storage carousel is shown in Figure 14:



FIGURE 14: Storage Carousel

## Automatic Storage/Retrieval Systems (AS/RS)

These include an integrated computer-controlled system that combines the transport mechanism, storage medium and control with multiple automation levels for accurate and fast random product storage. In an AS/RS, an S/R machine can travel both horizontally and vertically simultaneously, and can function in a narrow aisle which serves rack slots present on both sides of the aisle.

Some advantages of AS/RS are better material control, fewer material handlers and effective use of storage space. On the other hand, some disadvantages are high maintenance and capital costs.

There are four types of AS/RS. These are discussed as follows:

- **Unit load AS/RS:** These pieces of equipment are used for storing and retrieving loads that are unitised or palletised and have weight more than 500 lbs. Stacking heights of these equipment are up to 130 ft., while most of the heights range from 60 to 85 ft. with 5 to 6 ft-wide aisles and double-deep or single-deep racks.

A unit load AS/RS is shown in Figure 15:

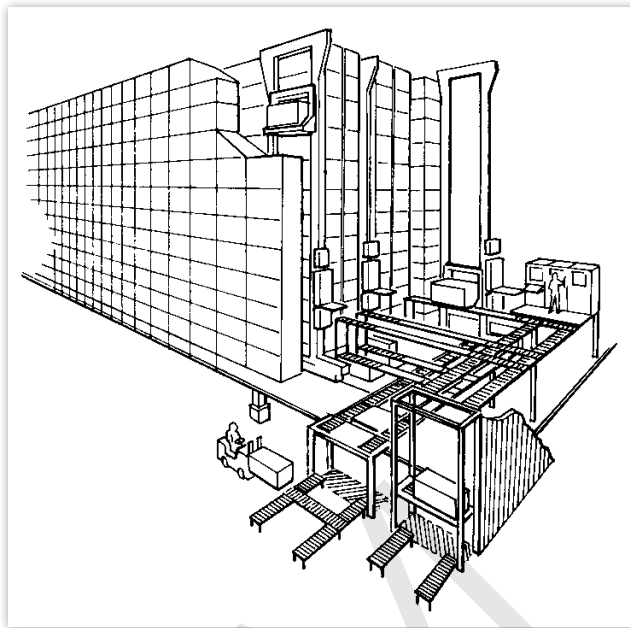

FIGURE 15: Unit Load AS/RS

- **Miniload AS/RS:** These storage equipment are used for storing or retrieving tools and small parts that can be stored in a drawer or storage bin. They allow the end of aisle replenishment and picking. Their bin capacities range from 200 to 750 lbs while stacking heights range from 12 to 20 ft. When used in kitting, assembly and testing for delivering small part containers, they are called microload AS/RS.

A miniload AS/RS is shown in Figure 16:

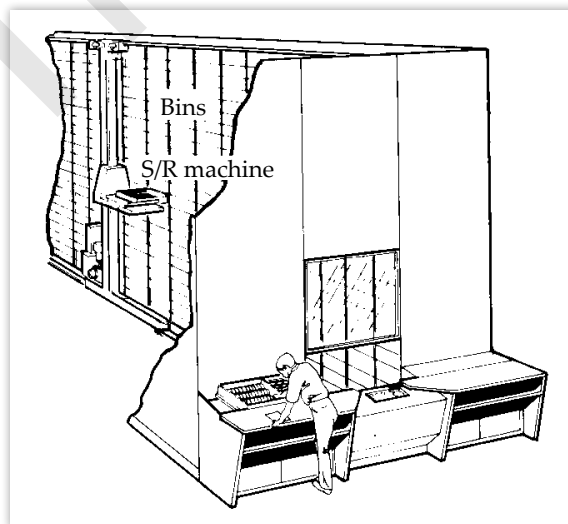

FIGURE 16: Miniload AS/RS

- **Man-on-board AS/RS:** These storage equipment are utilised for in-aisle picking in which an operator picks materials from bins, drawers or shelves within the storage structure. They have both automatic and manual controls. Their S/R machines are similar to turret trucks or order pickers. When outside an aisle, they can run as an industrial truck.

A man-on-board AS/RS is shown in Figure 17:

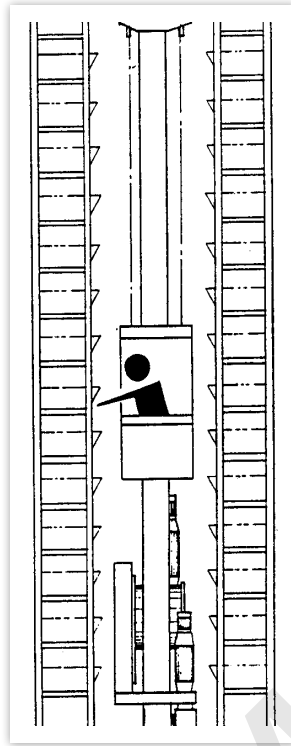

FIGURE 17: Man-on-Board AS/RS

- **Deep-lane AS/RS:** These storage equipment are similar to unit load AS/RS. The difference is that one can store loads to greater depths in a storage rack. In these types of equipment, rack entry vehicles are used for carrying loads into racks which are controlled by the S/R machine. When used for automatically retrieving individual cases or items, these are called automated item retrieval systems.

A deep-lane AS/RS is shown in Figure 18:

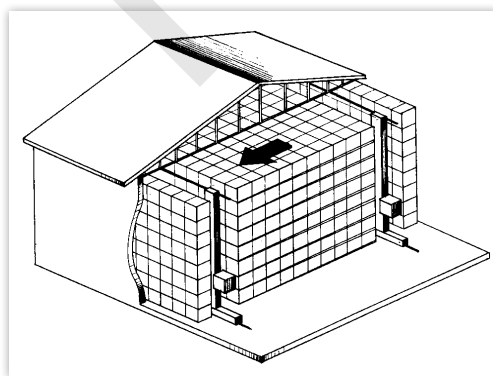

FIGURE 18: Deep-Lane AS/RS

### Split-Case Order Picking System

These systems allow fully automated picking of separate items. There are two types of split-case order picking systems, i.e., magazine/dispenser-based systems and robotics-based systems. While the former ones are similar to vending machines, but

**NOTES**

are larger in size, the latter ones are constructed similar to robotic pick and place palletisers. A split-case order picking system is shown in Figure 19:

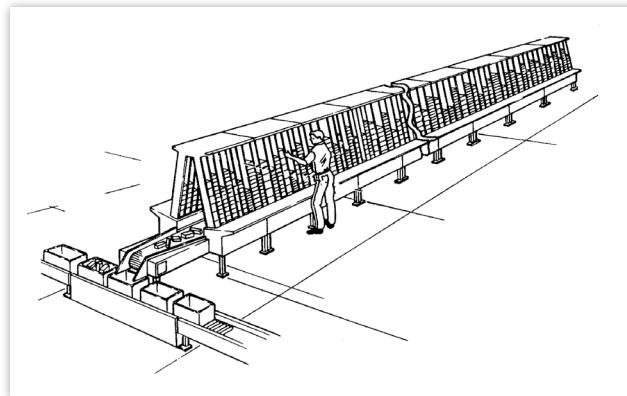

**FIGURE 19: Split-Case Order Picking System**

**Mezzanine**

Mezzanines are an inexpensive medium for creating additional storage space. They need a large clear space and, hence, are used in those activities that do not need much headroom, such as block storage. This storage equipment needs at least 14 ft. of clear space. A mezzanine is shown in Figure 20:

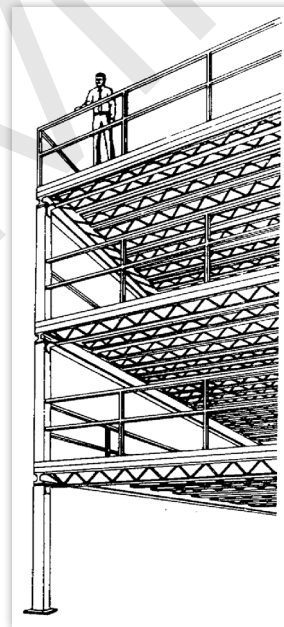

**FIGURE 20: Mezzanine**

**SELF ASSESSMENT QUESTIONS**

5. \_\_\_\_\_ equipment can be defined as the mechanical equipment that is used to move, store, control and protect goods and products through the warehousing process.
6. Stacking frames are interlocking units that allow load stacking to avoid crushing. (True/False)

7. Match the following:

List 1	List 2
1. Unit load AS/RS	a. These are used in those activities that do not need much headroom and need at least 14 ft. of clear space.
2. Man-on-board AS/RS	b. Loads are sustained by rails with upright beams attached to them.
3. Mezzanines	c. In this process, several product demands from orders are combined into one picking instruction.
4. Batch picking	d. These equipment are used for storing and retrieving loads that are unitised or palletised.
5. Drive-through rack	e. These storage equipment are utilised for in-aisle picking in which an operator picks materials from bins, drawers or shelves within the storage structure.

a. 1-d, 2-e, 3-a, 4-c, 5-b

b. 1-a, 2-c, 3-b, 4-e, 5-d

c. 1-d, 2-e, 3-a, 4-c, 5-b

d. 1-c, 2-b, 3-e, 4-d, 5-a

## 10.5 SUMMARY

- In a warehouse, storage equipment is used to hold or buffer materials for a period of time. There are various types of storage equipment that can be used to store materials.
- Warehousing has an important role to play in the logistics system of organisations. In a warehouse, a number of varied activities are performed to ensure adequate fulfilment of consumer needs. In combination with other logistics activities, it provides the required customer service levels.
- Product movement can be deemed as shifting goods while undertaking various warehousing activities in which goods are moved from one place to another.
- Receiving and putaway includes unloading goods or products from the transportation equipment, performing a count and standard verification as per records, checking the goods for any damage and updating inventory records.
- Shipping encompasses several tasks, such as moving and loading assembled orders physically on some transport carriers, inspecting the sequence and content of those orders, and keeping the inventory records updated.
- A pure cross-docking activity includes only organising the materials transferred from the inbound receiving dock to the outbound one while avoiding other activities, such as storing, putaway and order filling.
- Product storage can be of two types, i.e., long-term or semi-permanent storage, and short-term or temporary storage.

## NOTES

- Long-term or semi-permanent storage involves storing products more than what is required for the purpose of replenishment.
- To administer warehouse operations, managers need to have timely and precise information. Therefore, importance is given to the information transfer activity.
- A successful warehousing operation is the result of this information flow in addition to data on personnel and customers, space utilisation and other relevant parameters.
- 'Goods picking' or 'order picking' is a term used to define an activity under which a number of goods are collected from a warehouse in order to fulfil multiple independent orders received from customers.
- The picking process plays a major role in terms of impact on customers and resource utilisation. Therefore, it is necessary to optimise the picking process which results in increased productivity, reduced costs and remaining competitive.
- Organisations that have distribution centres and warehouses develop a tendency to improve their productivity while being preoccupied with reducing costs.
- Manual picking methods include the process of picking merchandise, items or products from a warehouse without taking any help of an application or any other equipment that automates a few or all activities.
- Automated picking methods are those that include placing, picking and getting materials or items from warehouses with the use of computerised systems integrated with various applications and equipments.
- In automated picking, material movement takes place in part or completely by robotics or machines.
- In this picking system, a computerised voice system provides orders to workers on what needs to be picked, from where to pick and what quantity needs to be picked.

## 10.6 KEY WORDS

- **Cross-docking:** This activity generally involves getting products or goods from one source and consolidating them with others from other sources that have the same destination, and finally, sending the consolidated lot to the customer quickly.
- **Material handling equipments:** These can be defined as the mechanical equipments that are used to move, store, control and protect goods and products through the warehousing process.
- **Pallet picking system:** This system combines the use of automated cranes, pallet conveyors and the sorting system to make sure that the product management and standard capacity are maintained.
- **Product movement:** It can be deemed as shifting goods while undertaking various warehousing activities, in which, goods are moved from one place to another.
- **Voice-directed picking systems:** In this picking system, a computerised voice system provides orders to workers on what needs to be picked, from where to pick and what quantity needs to be picked.

## 10.7 CASE STUDY: WAREHOUSING ACTIVITIES FOR A HOME CONSTRUCTION AND REPLACEMENT MATERIALS MANUFACTURER

NOTES

For the past twenty years, a local manufacturer and supplier dealing in home construction and replacement materials was running his own warehouse operations. He aimed to improve the measures to avoid traffic and storage issues while increasing its manufacturing footprint without any extra real estate costs. The organisation needed much more than standard plant deliveries and pallet movements. Warehouse flexibility and responsiveness were other concerns too.

With the help of some industry experts, the organisation implemented the following improvement activities:

- Included value-added and customised tasks, such as cutting parts to specific dimensions, pre-drilling and bending parts to specific shapes
- Consolidated both finished and raw manufacturing parts, especially building parts in customised racking
- Included sequencing and kitting ordered parts for Just-In-Time (JIT) delivery straight to the production line for the purpose of assembly
- Started shipping to various regional plants to process, finish or final assembly

With the help of these additional steps, the organisation could improve on storage effectiveness, save time, improve accuracy and save labour costs. The organisation operates in a region where building construction is seasonal. Therefore, the organisation also implemented a 'flexible wall' storage option, which allowed it to adjust to the weather conditions as the space contracts and expands. Now, the organisation need not pay a fixed amount of money for the warehouse space and labour if it is not needed.

As a result of these activities, the manufacturer realised many benefits.

The foremost benefit was that it could swiftly fulfil to Just-In-Time orders while avoiding storage and traffic problems at its manufacturing units. This allowed the organisation to expand and generate more inventory.

The other benefit was the ease of working of its management staff as the processes became more streamlined and productive. The organisation could increase flexibility and responsiveness in its warehouse activities while customising its logistics services.

Source: *murphywarehouse.com*

### QUESTIONS

1. What did the manufacturer want to improve?  
(Hint: Avoid traffic and storage issues, increase manufacturing footprint, etc.)
2. What were the concerns of the organisation?  
(Hint: Warehouse flexibility and responsiveness)

## NOTES

3. What were various activities implemented by industry experts?  
(**Hint:** Cutting parts to specific dimensions, pre-drilling and bending parts to specific shapes, etc.)
4. With the implementation of flexible wall storage, what was the organisation able to do?  
(**Hint:** Adjust to the weather conditions as the space contracts)
5. What benefits were availed by the management staff?  
(**Hint:** Processes became more streamlined, productive, etc.)

**10.8 EXERCISE**

1. Explain various warehouse activities in detail.
2. Explain various types of activities that are involved in product movement.
3. What are various types of automated picking? Explain in detail.
4. Provide and explain the examples of automated picking.
5. What are various types of storage equipment? Explain in detail.

**10.9 ANSWERS FOR SELF ASSESSMENT QUESTIONS**

Topic	Q. No.	Answer
Warehousing Activities	1.	Product movement
	2.	False
Goods Pickers	3.	Automated picking
	4.	True
Handling Equipment	5.	Material handling
	6.	True
	7.	a. 1-d, 2-e, 3-a, 4-c, 5-b

**10.10 SUGGESTED BOOKS AND E-REFERENCES****SUGGESTED BOOKS**

- Richards, G. (2014). *Warehouse Management: A Complete Guide to Improving Efficiency and Minimizing Costs in the Modern Warehouse*. Ed. 2. Kogan Page.
- Tompkins, J., & Smith, J. (2012). *The Warehouse Management Handbook*. Raleigh, N.C.: Tompkins Press.

**E-REFERENCES**

- Inc, v. (2019). Order picking systems. Retrieved 6 December 2019, from <https://www.viastore.com/en-us/%20warehouse-systems/order-picking-systems/>
- Storage Equipment. (2019). Retrieved 6 December 2019, from <http://materialhandlingequipment.easy2source.com/storage-equipment/>

# Health and Safety Issues in Warehousing

## Table of Contents

---

- 11.1 Introduction**
- 11.2 Risk Assessment in Warehousing**
  - 11.2.1 Layout and Design of a Warehouse
  - 11.2.2 Fire Safety
  - 11.2.3 Slips and Trips
  - 11.2.4 Manual Handling
  - 11.2.5 Working at Height
    - Self Assessment Questions
- 11.3 First Aid and Other Health and Safety Arrangements**
  - Self Assessment Questions
- 11.4 Warehouse Employee Occupational Safety and Health**
  - Self Assessment Questions
- 11.5 Summary**
- 11.6 Key Words**
- 11.7 Case Study**
- 11.8 Exercise**
- 11.9 Answers for Self Assessment Questions**
- 11.10 Suggested Books and e-References**

**LEARNING OBJECTIVES**

*After studying this chapter, you will be able to:*

- Explain how to perform risk assessment in a warehouse with respect to its layout and design
- Discuss warehouse risk assessment performed for fire safety and slips and trips
- Elucidate warehouse risk assessment measures for manual handling and working at height
- Explain first aid, and other health and safety arrangements performed in a warehouse
- Describe warehouse employee occupational health and safety measures

**11.1 INTRODUCTION**

In the previous chapter, you studied various warehousing activities, such as product movement, product storage and information transfer. You also studied different types of automated picking along with its examples. Later, you became familiar with various types of storage equipment that are used in warehouses.

Identifying health and safety issues in a warehouse is one of the major concerns for an organisation. Issues related to health and safety are the main reasons of occupational hazards that can happen at warehouse premises. After identifying these main reasons, organisations need to recognise the actions that need to be taken to reduce, if not totally eliminate, those reasons. For getting better results from the efforts, the workforce and employee safety representatives should also be involved in the process of identifying both the problems and the plan of action for reducing health and safety hazards.

Most of the health and safety issues can be identified while planning the warehouse layout and design. Timely removal of such issues brings success. In this chapter, you will learn the key points to be considered while planning the structure of the warehouse while taking into account employees' health and safety.

Major warehouse safety concerns arise from fire, slips, trips, manual handling of material and equipment, and working at height.

This chapter will provide a detailed explanation of how to avoid these issues. Later in this chapter, you will learn about warehouse equipment legislations that are applicable to warehouse safety. You will also understand how to deploy first aid, and other health and safety arrangements. In addition, you will become familiar with the warehouse employee occupational health and safety concerns and procedures to avoid them.

**11.2 RISK ASSESSMENT IN WAREHOUSING**

Warehousing and storage activities are large in number and can result in multiple safety risks and hazards. With effective health and safety management, organisations can look at those risks, and implement practical solutions and measures to control them. When an organisation does so, it not only protects its most valuable asset, i.e.,

employees, but it also protects the external public from any harm. In addition, the organisation also safeguards goods, premises, reputation, equipment, etc.

According to a report, in the warehousing industry, major injuries are caused by slipping and tripping of employees that result in fractures or hospitalisation for more than one day. Past trends show that warehouse employees do not consider slip and trip accidents as serious accidents, especially involving forklift trucks. However, regular patterns show that slips and trips, resulting from falls or due to a high impact on structures and objects, cause serious injuries. Table 1 shows the causes of major injuries (in percentage) in warehouses as per a survey:

**TABLE 1: Causes of Major Injuries (in Percentage) in Warehouses**

Causes of Major Injuries	Percentage
Slip or trip	26%
Manual handling	18%
Falls from height	16%
Hit by a moving or falling object	13%
Hit by a moving vehicle	10%
Hit something fixed or stationary	8%
Other kinds of accidents	9%

Table 1 depicts that the second major cause of injuries is manual handling of loads. The first step in managing health and safety in warehouses is identifying priorities, i.e., performing risk assessment. It is an important step to protect employees and business while complying with the applicable laws. It helps in focussing on the risks that matter the most and the ones that have the potential to harm anyone. Legally too, organisations need to perform risk assessment for their establishments in order to put a control plan in place.

In simple words, risk assessment is a careful examination of work activities or things that can harm people, so that organisations can initiate necessary precautions to prevent such harm. It is the right of workers and others to remain protected from any kind of failure.

The steps to perform risk assessment are outlined in Figure 1:

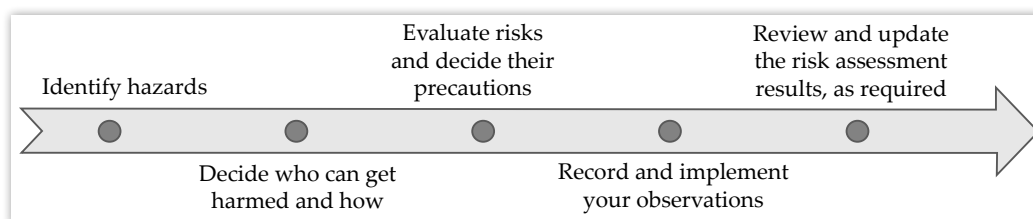

**FIGURE 1: Steps to Perform Risk Assessment**

If risk assessment involves five or more people, their important observations must be recorded and the assessment record should be purposeful.

Sometimes, many warehouse risks are already in control, for example, the use of the right kind of industrial trucks with properly trained drivers. However, one must also consider other problems, such as monitoring, supervision and maintenance.

## NOTES

Examining accidents helps organisations recognise any further actions to be performed. The result of this examination can also aid in reviewing the risk assessment. Sometimes, the actions to tackle accidents are obvious. However, at other times, accidents need to be thoroughly examined to come up with a solution, for example, by looking at work systems. Table 2 shows a checklist that organisations can use to examine incidents and accidents:

TABLE 2: Checklist to Examine Incidents and Accidents

Check what happened
<ul style="list-style-type: none"> <li>• Figure out the circumstances that are causing incidents or accidents to happen</li> <li>• Recognise the hazards that caused those incidents or accidents, such as:               <ul style="list-style-type: none"> <li>◆ Work environment, such as lighting, floor surface or temperature</li> <li>◆ Plant, tools, equipment or substances</li> <li>◆ Skills and training of people involved</li> <li>◆ The way of organising work</li> </ul> </li> </ul>
Prevent the incident or accident to happen again
<ul style="list-style-type: none"> <li>• Recognise what has already been implemented for minimising risks</li> <li>• Identify additional precautions that are needed for preventing similar incidents or accidents</li> <li>• Make sure to implement additional precautions</li> <li>• Review additional precautions for ensuring they remain effective</li> </ul>

### 11.2.1 | LAYOUT AND DESIGN OF A WAREHOUSE

The design of a warehouse should be such in a way that it creates a safe environment for people, materials and goods. If the design and layout of a warehouse are good, they reduce accidents, including the ones that involve people and vehicles tripping and slipping.

The materials and goods movement include the use of various vehicles that account for a series of warehouse accidents. Safe traffic management is a necessity. It needs to include procedures and methods for reception, arrival, loading, unloading and vehicle movement within the facility. Vehicles and people should be separated to a possible and practical extent. When working on the design and layout of the warehouse, organisations need to consider areas, such as pedestrian traffic routes, storage aisles, areas and gangways, ramps and staircases, and emergency escape routes.

#### Dimensions and Space of Rooms

Within a room, the floor area should be sufficient enough to allow workers to move freely. The recommended minimum space is m<sup>3</sup> for each person; however, this needs to be increased if the furniture is covering a large space in the room.

#### Traffic Routes and Floors

Traffic routes and floors need to be designed and built for withstanding heavy load, for example, physical damage due to wheeled equipment, chemical substance corrosion or lift trucks.

Floors should be efficient enough to bear the overall load that would be put on them or at any stock-loading point, with or without pallet racking. There should not be an

overload on the floors. While considering the traffic that can pass over them, traffic routes need to have suitable stability and strength. People can fall in deep holes and, hence, they should be properly covered and fenced.

Aisles, storage areas and gangways need to be marked clearly on the floors. For ensuring that mechanical handling equipment is planned properly, gangways need to be wide enough. In addition, surfaces of traffic routes and floors need to be free from all kinds of slopes, holes and slippery or uneven surfaces. Such surfaces, if present, can cause:

- loss of control or instability in vehicles or loads
- a person to lose control or drop anything being carried or lifted
- a person to trip, fall or slip

Slopes should not be steeper. Steep and moderate ramps and slopes used by people with disabilities should have secure handrails. Traffic routes and floors have an important role to play when it comes to managing risks related to trips and slips. In cases where it is not possible to avoid temporary obstruction, one should take steps for warning drivers or people involved with the use of hazard cones.

Within the workspace, when equipment or furniture is being moved, it should be kept in mind that it should not hurt anyone. One should try to move it in a single operation. In addition, vehicles should not be parked where they can become a hazard.

### 11.2.2 | FIRE SAFETY

A warehouse fire can have serious consequences for its property and human lives. One should take the recommended steps for avoiding fires and ensuring the safety of people when a fire starts. In most facilities, including warehouses, the local fire and rescue authority enforces fire safety.

For meeting fire safety requirements, organisations need to undertake a fire risk assessment. This is necessary to ensure that fire precautions, fire prevention measures and fire safety procedures are in place.

Fire risk assessment includes the steps as shown in Figure 2:

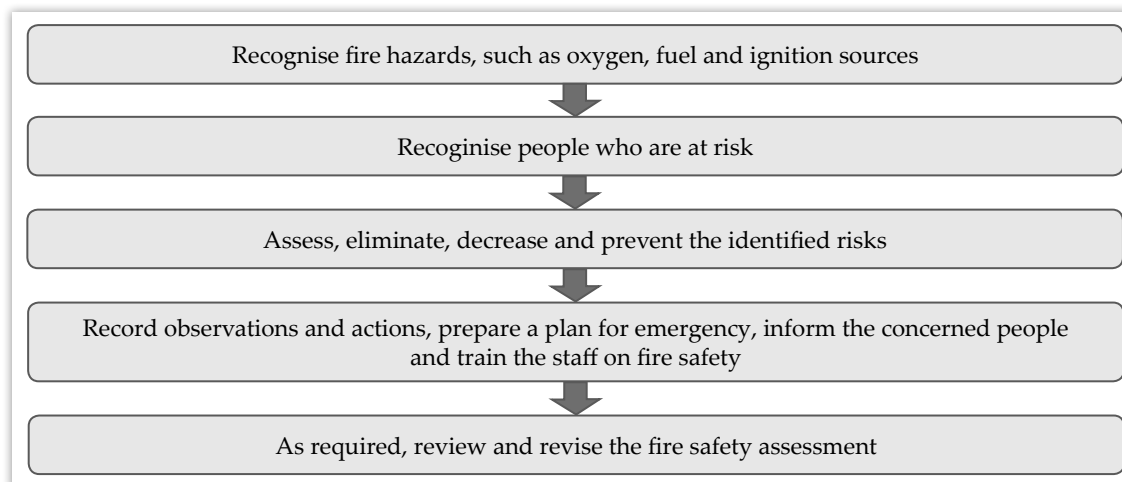

FIGURE 2: Steps to Perform a Fire Risk Assessment

## NOTES

It is recommended to create an effective and long-term strategy for reducing hazards and risks that may start a fire. This implies segregating combustible and flammable materials from the sources of ignition. Organisations need to consider the following points:

- Ensure that organisations have enough storage areas as per their needs and have adequate control in place while storing combustible materials.
- Perform housekeeping to keep waste materials in appropriate containers and prevent the accumulation of combustible items before removing them from a facility and creating a management plan.
- Make sure that the machinery and equipment are properly maintained, cleaned and used.
- Ensure proper storage of dangerous substances, such as gas cylinders, aerosols, explosives, fireworks and flammable liquids.
- Install and maintain electrical equipment while safely utilising the services of a skilled person as these types of equipment are the major causes of accidental fires.
- Perform a periodic visual inspection of electrical equipment to ensure that they are not congested and not placed near combustible materials that can overheat the equipment.
- Properly manage the work and modifications being done to the building because fires can occur more frequently when any modifications or refurbishments are happening in the building.
- Look for ignition sources that can initiate smoking and eliminate them.
- Look out for obstructions, fire hazards and blocked fire exits, which are usually found out in stairways and corridors.
- Check out for easy paths through which fire and smoke can spread and prevent them; for example, fire stop false ceilings or fill the unsealed holes in walls.
- Make sure that spreading fire and smoke are restricted using roof vents or sprinkler systems for allowing the smoke to escape.
- Ensure that combustible rubbish and materials which can cause significant fire risks and are stored usually near the building entry points or along with the building are properly discarded.
- In case of fire, help people with special needs and people outside the warehouse.

### 11.2.3 | SLIPS AND TRIPS

Accidents of slips and trips can occur anytime, anywhere. Generally, these accidents are considered unimportant. However, in warehouses, slips and trips are serious concerns and account for the one-third of major injuries that can result in hospitalisation and broken bones. An individual suffers a lot in terms of money, pain and worry. Employers also bear a high cost in terms of production delays, insurance costs and image loss. To avoid slip and trip accidents, the warehouse should adhere to the following measures related to its work environment:

## Floors and Traffic Routes Safety

Floors and traffic routes should be built:

- to have an efficient drainage system as required
- to be suitable to serve their purpose
- to not be slippery or uneven to cause fall, slip or trip
- to be free from excessive slopes and holes
- to have proper and enough lighting
- to be free from substances, articles or obstructions that can cause falls or slips

## Housekeeping and Maintenance

The workplace needs:

- to be clean
- to have remedies to tackle accidental spillage
- to not accumulate any waste materials except in proper vessels
- to have properly maintained systems and devices
- to have staircases with at least one handrail and two handrails if there is a risk of falling

To control or eliminate slips and trips, efficient health and safety management should be in place, which includes recognising problem areas, deciding the plan of action, implementing the planned actions and checking if the actions have been effective.

## Managing Trip Hazards

Trip hazards include shrink wrapping, waste packaging, cables on walking areas, obstructions, banded strapping loops, pallets, ridges, bumps, uneven surfaces, holes, dusty floors, wet floors, condensation, cracks, telephone and electrical socket outlets, and many more. Factors, such as rushing around, poor walkways organisation, incorrect cleaning materials, incorrectly placed reflections or mirrors, fatigue and distractions, can cause trips in the warehouse.

Keeping traffic routes and floors free from any kind of obstruction, especially near escalators, stairs, steps, emergency routes and moving walkways, is the first step towards managing trip hazards. Organisations can adopt the following measures to manage trip risks:

- Remove uneven surfaces and holes near work areas outside the warehouse building and on floors inside the building.
- Mark boundaries and designate walkways clearly while ensuring that electric cables and pipes do not obstruct paths.
- Ensure that equipment and goods do not obstruct paths.
- Make sure there is enough storage for preventing goods to be stored in traffic routes and walkways.

## NOTES

- Provide proper lighting.
- Plan disposal of waste for ensuring that it does not accrue on walkways or floors.
- Ensure the use of proper footwear.
- Mark obstacles that cannot be removed clearly.
- Ensure that any material that falls on traffic routes is cleared as and when encountered.
- Inspect the workplace regularly for ensuring that there are no hazards that can cause trips.
- Repair the floor deterioration and fill potholes as soon as they are visible.

### Managing Slip Hazards

Slips hardly occur on dry and clean floors. They happen when something gets in between the floor and shoe sole, and obstructs them from creating a good contact. Therefore, most slip accidents happen when the floor is contaminated and wet.

Substances, such as dry powders, cleaning products, oil, water and food products can contaminate floors and make them slippery. Other items, such as plastic bags and polythene stretch wrapping, can cause slips too. Specific slip risks are related to temperature-controlled storage units.

Contamination caused by materials leakage is another issue that can cause slips. Therefore, person in charge should check leakage in goods when they arrive, have a proper system to deal with leakage, maintain equipment, plant and environment, and prevent contaminants from getting outside and on floors by installing entrance mats. Some other ways to control contamination are:

- Choosing the right kind of regime for regular contamination removal from floors
- Providing dry cleaning methods, such as vacuum cleaners, for removing contamination
- Using wet cleaning methods, such as mopping, when the floor is completely dry
- Using barriers for keeping out of the wet area when cleaning
- Using spot cleaning for removing non-hazardous liquid spillage, as it prevents contamination from spreading
- Having the staff always available for cleaning up spills

#### 11.2.4 | MANUAL HANDLING

For all manual handling equipment, manual handling assessment must be performed. This assessment should recognise the areas of improvement and other actions for reducing the risk of injuries associated with manual handling operations. When performing such an assessment, an organisation must consider the following factors:

- **Task:** Find out the task that includes any predictable risks. Consider excessive lifting, excessive pulling or pushing distances, unsatisfactory posture or body movements and situations wherein any load is needed to be manipulated or held at a distance from the body or requires repetitive handling.

- **Load:** Find out any loads that are not suitable for manual handling, such as loads that are slippery, bulky, wet, unstable or unpredictable.
- **Working environment:** Figure out the conditions that increase injury risks due to manual handling operations; for instance, narrow aisles, constricted work areas and extreme temperature areas.
- **Capability of individuals:** Identify employees who need any specific assessment before performing any manual handling operations. For example, people who have some known medical conditions, new or pregnant mothers, people who have suffered any injuries due to manual operations or new workers.
- **Other factors:** Find out if a posture or movement exists that is hindered by clothing or personal protective equipment. Consider other organisational factors that give rise to the risks associated with manual handling operations.

After assessing the risks associated with manual handling operations, organisations need to identify practical solutions to eliminate these risks. Solutions can include redesigning the system of work or tasks, changing the heights of shelves or installing mechanical handling equipment.

### 11.2.5 | WORKING AT HEIGHT

In a workplace, falls figure among the most common reasons for fatal injuries. Fractured skulls or broken bones can happen because of these issues. Each year, a large number of employees who work in warehouses get injured because of falling, but many of these incidents can be prevented by taking adequate effective measures.

Working at height means working below or above the ground level where someone can be injured after falling. In these situations, people can fall from:

- work equipment, for example, using step ladders
- an unprotected edge opening
- a fragile surface
- the ground level into a hole in the ground or an opening in a floor

Working at height should be performed in a safe manner and employers must deploy practical procedures to prevent people from falling. They should allow their employees to:

- avoid working at height as far as possible by using long-handled tools
- use equipment that has edge protection
- work from a safe place
- minimise the consequences and distance of any potential falls, for example, by using the fall arrest equipment
- get training for reducing the risk of falls

Employers also need to take effective measures in the following areas:

- **Maintenance work:** All height works that include maintenance work (although being performed by a contractor) need to be properly supervised, planned and

## NOTES

performed in the safest way possible. Employers must assess the experience and knowledge of contractors, and agree to use the recommended work methods that include the use of the right kind of equipment.

- **Training of employees:** Employers must ensure that each employee who needs to work at height is trained and capable, or at least being supervised by a capable person. Equipment, such as tower scaffold and mobile elevating work platform (MEWP), need special training. Additional training programs should be in place when it is not practical to avoid fall effects.
- **Reporting mechanism:** People and employees working under someone need to report on safety hazards and utilise supplied equipment in a proper manner while following recommended instructions and training.
- **Equipment:** If working at height is unavoidable, equipment should be selected very carefully. Proper consideration should be given to the people doing tasks and activities and the place where they will be performed. The frequency and length of tasks also need to be considered. Remember that ladders or step ladders do not avoid falls and are not work platforms. Selecting alternative equipment is not practical when the task is of short duration and low risk.
- **Inspection:** Inspection must be performed according to the frequency determined by risk assessment, which depends on certain factors, such as the environment and the extent of equipment use. Immediate inspections need to be performed after any incident that would have an impact on the integrity of equipment. Make sure that pre-use checks are in place for all defects that can affect the stability and strength of the equipment. Proper inspection should be in place for Mobile Elevating Working Platforms (MEWPs) at regular intervals. In addition, step ladders and ladders should be checked periodically for hinges, joints, platforms, rails, legs, brakes, wheels, sharp edges, footpads, woods and steps.
- **Emergencies:** In warehouses, where working at height is unavoidable, employers need to have emergency plans in place. MEWP used in emergencies is depicted in Figure 3:



FIGURE 3: A Mobile Elevating Working Platform

**SELF ASSESSMENT QUESTIONS****NOTES**

1. In warehouses, where working at height is unavoidable, employers need to have emergency plans in place. (True/False)
2. Immediate \_\_\_\_\_ needs to be performed after any incident that would have an impact on the integrity of equipment.

**11.3 FIRST AID AND OTHER HEALTH AND SAFETY ARRANGEMENTS**

Warehouses are full of potential risks for the health and safety of employees working there. Therefore, for the safety of employees, a comprehensive and effective first aid strategy should be in place.

The first aid kit is an essential component of the employee safety regime in any warehouse. This kit must have the following things:

**Bandages, Dressings and Plasters**

The requirement of bandages, dressings and plasters in the warehouse first aid kit depends on the number of employees and nature of work. As a general rule, for a working environment that involves low hazards, there should be at least 20 sterile plasters, two large sterile wound dressings and four triangular bandages. These numbers significantly increase in the case of large warehouses. Organisations need to determine the number of dressings and plasters required based on the number of employees and potential risks present in the warehouse.

**Eyewash**

It is essential to keep a good stock of sterile eyewashes in the warehouses within access, especially in those warehouses that have harmful substances and liquids. After an eye is exposed to a harmful substance, the first 10 to 15 seconds are critical. In such situations, an accessible eyewash location can make a huge difference between permanent eye damage and full recovery.

**Burns Treatment**

Similar to exposure to harmful substances, recovery from burns is also dependent on how quickly first aid is given. Therefore, it is very important to keep the burns kit within reach when there are high risks of burning.

The potential for harm decides the extent to which one must be prepared for this risk. However, it is a good idea to always remain overequipped rather than underequipped.

**Effective Training**

Irrespective of how good a first aid kit is, its effectiveness depends on the expertise of the person performing the treatment. Therefore, in the warehouse environment, it is important to have individuals with the right kind of training.

Even the very basic first aid courses include instructions to perform specific procedures that are applicable in the warehouse environment. These include treating

## NOTES

wounds, burns and injuries sustained by falling from a height. Therefore, employers must ensure that their warehouses have trained first aiders or the persons appointed to give first aid. A person appointed to give first aid makes arrangements for first aid, which include looking for facilities and equipment and calling emergency services as and when required.

Let us now talk about other health and safety measures that should be applied in warehouses. A well maintained and good warehouse management practice ensures safety. Some important practices to manage warehouses to ensure health and safety are described as follows:

- It is important to keep proper housekeeping.
- For easy identification, packing needs to be secure, having stable labels with acceptable signs.
- Preferably, highly hazardous materials should be low in inventory.
- For minimising the risk of the deterioration of packages, goods and labels, the working procedure should follow the 'First-In-First-Out' principle.
- At any point in time, good record keeping aids in knowing the precise information on items' availability.
- All employees working in the warehouse should be apprised in writing about:
  - safety and hygiene instructions
  - emergency procedures and instructions
  - material safety data sheet of all transported and stored materials
  - correct and safe operations of storage materials and equipment
- Proper training should be in place for all employees which include mock rehearsals.
- Sensors for leaks and small fires should be installed at tactical locations.
- Proper hygiene personal protective equipment and clothing amenities should be there for all employees.
- The basis of risk analysis should be offsite and onsite emergency plans.
- Arrangements of first aid should be there every time.
- Arrangements should be made for stopping any leaks and spillages immediately, as well as for quick cleaning activities.
- Employees should have entry permits. It is important to have strict control over the people entering the warehouse.

## SELF ASSESSMENT QUESTIONS

3. It is not important to have strict control over the people entering the warehouse. (True/False)
4. The \_\_\_\_\_ kit is an essential component of the employee safety regime in any warehouse.

**ACTIVITY****NOTES**

Visit a warehouse and observe risk assessment measures taken in the warehouse. Examine the safety measures that are followed and the basic safety equipment that is provided in the warehouse. Also suggest some ways to improve the organisation's safety standards.

**11.4 WAREHOUSE EMPLOYEE OCCUPATIONAL SAFETY AND HEALTH**

Occupational Safety and Health (OSH), occupational health, Occupational Health and Safety (OHS) or Workplace Health and Safety (WHS) is a field related to the welfare, health and safety of employees at work. The prime aim of occupational safety and health program is to promote safe working conditions. It can also include the protection of family members, coworkers, customers, employers and other people who get affected by the workplace environment.

As per the common law, employers are responsible for taking care of their employees' safety. As per the statute law, there may be additional general and specific duties, and government bodies that need to regulate health and safety issues at workplaces, depending on their jurisdiction.

In India, the Labour Ministry is responsible for formulating policies on occupational safety and health in warehouses and factories in consultation with the Directorate General of Factory Advice Service and Labour Institutes (DGFASLI). The ministry is responsible for enforcing these policies through inspectorates of dock safety and inspectorates of factories. DGFASLI is technically an arm of the Ministry of Labour & Employment, Government of India, that provides advice to factories on different problems related to the health, safety, wellbeing and efficiency of people at workplaces. The technical support to formulate these rules is provided by DGFASLI. It also performs occupational safety surveys and conducts training programs to enforce related policies.

**EXHIBIT****NATIONAL POLICY ON SAFETY, HEALTH AND ENVIRONMENT AT WORKPLACE**

The National Policy on Safety, Health and Environment at Workplace seeks to achieve the national objectives of bringing improvement in safety, health and environment at workplace. The policy aims to achieve:

- Continuous reduction in the incidence of work-related injuries, fatalities, diseases, disasters and loss of national assets.
- Improved coverage of work-related injuries, fatalities and diseases, and provide for a more comprehensive database for facilitating better performance and monitoring.
- Continuous enhancement of community awareness regarding safety, health and environment at workplace areas.
- Continually increasing community expectations of workplace health and safety standards.

## NOTES

- Improving safety, health and environment at the workplace by the creation of 'green jobs' thereby, contributing to sustainable enterprise development.

To achieve these objectives, the following action program is drawn up and, where necessary time-bound action program would be initiated.

### Enforcement

- By providing effective enforcement machinery, as well as suitable provisions for compensation and rehabilitation of affected persons.
- By effectively enforcing all applicable laws and regulations concerning safety, health and environment at the workplace in all economic activities through an adequate and effective labour inspection system.
- By establishing suitable schemes for subsidy and provision of loans to enable effective implementation of the policy.
- By ensuring that employers, employees and others have separate but complementary responsibilities and rights with respect to achieving safe and healthy working conditions.
- By amending expeditiously existing laws relating to safety, health and environment, and bring them in line with the relevant international instruments.
- By monitoring the adoption of national standards through regulatory authorities.
- By facilitating the sharing of best practices and experiences between national and international regulatory authorities.
- By developing new and innovative enforcement methods including financial incentives that encourage and ensure improved workplace performance.
- By enacting enabling legislation on safety, health and environment at the workplace.
- By setting up safety and health committees wherever deemed appropriate.

### National Standards

- By developing appropriate standards, codes of practices and manuals on safety, health and environment for uniformity at the national level in all economic activities that are consistent with international standards and implementation by the stakeholders in true spirit.
- By ensuring stakeholders' awareness of and accessibility to applicable policies, documents, codes, regulations and standards.

### Compliance

- By encouraging the appropriate government to assume the fullest responsibility for the administration and enforcement of occupational safety, health and environment at workplace, provide assistance in identifying their needs and

responsibilities in the area of safety, health and environment at workplace, to develop plans and programs in accordance with the provisions of the applicable acts and to conduct experimental and demonstration projects in connection therewith.

- By calling upon the cooperation of social partners in the supervision of the application of legislations and regulations relating to safety, health and environment at the workplace.
- By continuous improvement of occupational safety and health by following the systems approach to the management of occupational safety and health including developing guidance on occupational safety and health management systems, strengthening voluntary actions, including mechanisms for self-regulatory concept and establishing auditing mechanisms which can test and authenticate occupational safety and health management systems.
- By providing specific measures to prevent catastrophes, and to coordinate and specify the actions to be taken at different levels, particularly in industrial zones with high potential risks.
- By recognising the best safety and health practices and providing facilitation for their adoption.
- By providing adequate penal provisions as a deterrent for violation of laws for the time being in force.
- By encouraging all concerned to adopt and commit to 'Responsible Care' and/or 'Corporate Social Responsibility' to improve safety, health and environment at workplace performance.
- By ensuring suitable accreditation machinery to recognise institutions, professionals and services relating to safety, health and environment at the workplace for uniformity and greater coverage and also authenticating a safe management system.
- By encouraging employers to ensure occupational safety and health management systems, and establish them in an efficient manner to improve workplace safety and health.
- By specifically focussing on occupational diseases, such as pneumoconiosis and silicosis, and developing a framework for its prevention and control as well as developing technical standards and guidelines for the same.
- By promoting safe and clean technology and progressively replacing materials hazardous to human health and the environment.

Similarly, there are other regulations with respect to awareness, research and development, occupational safety and health skills development, data collection, review and collection.

**Source:** <http://labour.gov.in/sites/default/files/SafetyHealthandEnvironmentatWorkPlace.pdf>

**SELF ASSESSMENT QUESTIONS**

5. The main objective of occupational \_\_\_\_\_ and \_\_\_\_\_ programs is to foster a safe work environment.
6. As per the common law, employers are not responsible for taking care of their employees' safety. (True/False)
7. Match the following:

List 1	List 2
1. First aid courses	a. is a careful examination of work activities or things that can harm people, so that an organisation initiates necessary precautions to prevent such harm.
2. Inspection	b. caused by materials leakage is another issue that can cause slips.
3. Contamination	c. instructions to perform specific procedures that are applicable in the warehouse environment including treating wounds, burns and injuries sustained by falling from a height.
4. Risk assessment	d. must be performed according to the frequency determined by risk assessment which depends on certain factors, such as the environment and extent of equipment use.

- a. 1-d, 2-c, 3-b, 4-a
- b. 1-c, 2-d, 3-b, 4-a
- c. 1-a, 2-b, 3-d, 4-c
- d. 1-c, 2-b, 3-a, 4-d

**11.5 SUMMARY**

- Warehousing and storage activities are large in number and can result in multiple safety risks and hazards. With effective health and safety management, an employer can look at those risks and implement practical solutions and measures to control them.
- The design of a warehouse should be such that it creates a safe environment for people, materials and goods. If the design and layout of a warehouse are good, they reduce accidents, including the ones that involve people and vehicles tripping and slipping.
- One should take the recommended steps for avoiding fires and ensuring the safety of people if a fire starts. In most facilities including warehouses, the local fire and rescue authority enforces fire safety.
- In warehouses, slips and trips are serious concerns and account for the one-third of major injuries that can result in hospitalisation and broken bones. An individual also suffers a lot in terms of money, pain and worry.
- For all manual handling equipment, manual handling assessment must be performed. This assessment should recognise the areas of improvement and other

actions for reducing the risk of injuries that can arise because of manual handling operations.

- Working at height means working below or above the ground level where someone can injure himself/herself after falling.
- Warehouses are full of potential risks for the health and safety of employees working there. Therefore, for the safety of employees, a comprehensive and effective first aid strategy should be in place.
- Occupational Safety and Health (OSH), occupational health, Occupational Health and Safety (OHS) or Workplace Health and Safety (WHS) is a field that is related to the welfare, health and safety of employees at work.
- Examining accidents helps organisations recognise any further actions to be performed. The result of this examination can also aid in reviewing the risk assessment.
- The design of a warehouse should be such that it creates a safe environment for people, materials and goods. If the design and layout of a warehouse are good, accidents including the ones that involve people and vehicles tripping and slipping are reduced.
- Floors should be efficient enough to bear the overall load that would be put on them or at any stock loading point, with or without pallet racking. There should not be an overload on the floors.
- Aisles, storage areas and gangways need to be marked clearly on the floors. For ensuring that mechanical handling equipment is planned properly, gangways need to be wide enough.
- A warehouse fire can have serious consequences for its property and human lives. One should take the recommended steps for avoiding fires and ensuring the safety of people when a fire starts.
- For meeting fire safety requirements, an organisation needs to undertake a fire risk assessment. This is necessary to ensure that fire precautions, fire prevention measures and fire safety procedures are in place.
- It is recommended to create an effective and long-term strategy for reducing hazards and risks that may start a fire. This implies segregating combustible and flammable materials from the sources of ignition.
- To control or eliminate slips and trips, efficient health and safety management should be in place which includes recognising problem areas, deciding the plan of action, implementing the planned actions and checking if the actions have been effective.
- After assessing the risks associated with manual handling operations, organisations need to identify practical solutions to eliminate risks.
- Employers must assess the experience and knowledge of contractors and agree to use the recommended work methods that include the use of the right kind of equipment.

## 11.6 KEY WORDS

- **Risk assessment:** It is a careful examination of work activities or things that can harm people, so that, organisations can initiate necessary precautions to prevent such harm.
- **Inspection:** These must be performed according to the frequency determined by risk assessment, which depends on certain factors, such as the environment and extent of equipment use.
- **Eyewash:** It is essential to keep a good stock of sterile eyewashes in the warehouses within access, especially in those warehouses that have harmful substances and liquids.
- **Directorate General of Factory Advice Service and Labour Institutes (DGFASLI):** It is technically an arm of the Ministry of Labour & Employment, Government of India, that provides advice to factories on different problems related to the health, safety, wellbeing and efficiency of people at workplaces.
- **Manual handling assessment:** This assessment recognises the areas of improvement and other actions for reducing the risk of injuries associated with manual handling operations.

## 11.7 CASE STUDY: HEALTH AND SAFETY MEASURES BY NESTLÉ

Nestlé, a Swiss transnational food and drink company headquartered in Vevey, Vaud, Switzerland, always considers risk elimination as a top priority in its facilities. For this, the confectionery giant deploys safety management basics which have always proved beneficial. In the past three years, Nestlé's focus on designing out risk has helped it reduce its injury rates for its York factory by more than 38%.

The design of Nestlé's risk assessment scheme is such that the company has observed a notable 75% fall in facility accidents. Similar to other safety management schemes, Nestlé's scheme is a simple one that includes recognising safety hazards right at the design stage before they could affect processes and equipment installed in its facilities. The company starts with the objective of designing a scheme that is safe and does not require the introduction of measures for making processes and equipment safe once they are operational.

The design stage includes examining all processes and modifications in the facility to find out the potential causes of ill health and accidents. The people involved in this examination look at the design proposal quite early in the procedure.

During this examination, they look for the key areas of goods receipt, packaging and shipping. For each of these areas, these people examine both the normal and the abnormal operations, and maintenance and cleaning against a checklist which helps them decide on the risks that fall under each category.

The checklist covers common reasons for ill health and accidents, and risks, such as trips, slips, falls, manual handling, hazardous substances, working at height and noise levels. The focus is to eliminate each risk. For example, if the examination highlights that during goods receipt, manual handling of materials can pose a risk,

the team tries to avoid the need for manual handling before devising any controls of minimising the risk at a later stage.

This assessment also involves workers from the floor as they are the people who have the exact experience and knowledge for anticipating such potential risks.

Nestlé utilised the design stage examination efficiently while introducing new silos in its York factory. The company deployed various changes as a result of going through the checklist and finding risk observations. One identified risk was related to the requirement of accessing the top of the silos and challenges that workers encountered due to carrying tools while getting to the top by using hooped ladders. To overcome this risk, the design was altered to provide proper stairs and using the hooped ladder only in an emergency.

A couple of more changes were implemented for the silos, which were as follows:

- A locked base to limit the access only to authorised people
- A ground-level incorporation
- Testing facilities for reducing the requirement to go to the top
- A cage to lift tools to a silo's top and lower people when an emergency arises

Source: *healthandsafetyatwork.com*

## QUESTIONS

1. What is the top priority at work for Nestlé'?  
(Hint: Elimination of risk and deployment of safety management)
2. What was the outcome of Nestlé's risk assessment scheme?  
(Hint: Nestlé witnessed a notable 75% fall in facility accidents)
3. What do factors at the design stage at Nestle include?  
(Hint: An examination of all processes and modifications in the facility, etc.)
4. Which key areas were considered while examining the facility design?  
(Hint: Goods receipt, packaging and shipping)
5. What changes were implemented for silos?  
(Hint: A locked base to limit the access only to authorised people, a cage to lift tools to a silo's top, etc.)

## 11.8 EXERCISE

1. What is the risk assessment in warehousing? Explain.
2. What are fire safety hazards and how to avoid them in a warehouse?
3. Explain the procedure to manage the trip and slip hazards.
4. Explain the fire and other safety arrangements performed in warehouses.
5. What is occupational safety and health?

**11.9 ANSWERS FOR SELF ASSESSMENT QUESTIONS**

Topic	Q. No.	Answer
Risk Assessment in Warehousing	1.	True
	2.	inspection
First Aid and Other Health and Safety Arrangements	3.	False
	4.	first aid
Warehouse Employee Occupational Safety and Health	5.	safety; health
	6.	False
	7.	b. 1-c, 2-d, 3-b, 4-a

**11.10 SUGGESTED BOOKS AND E-REFERENCES****SUGGESTED BOOKS**

- Richards, G. (2014). *Warehouse Management: A Complete Guide to Improving Efficiency and Minimizing Costs in the Modern Warehouse*.
- Heizer, J., Render, B., & Munson, C. (2015). *Principles of Operations Management*.

**E-REFERENCES**

- 4 Tips on How to Effectively Plan a Warehouse Layout Design | DEAR Cloud Inventory Management. (2019). Retrieved 10 December 2019, from <https://dearsystems.com/warehouse-layout-design/>
- Barry, B. (2019). Warehouse Layout Design Principles. Retrieved 10 December 2019, from <https://www.fcbco.com/blog/warehouse-layout-design-principles>

# Warehousing Strategy

## Table of Contents

---

- 12.1 Introduction**
- 12.2 Factors to be Considered in a Warehousing Strategy**
  - 12.2.1 Presence Synergies
  - 12.2.2 Industry Synergies
  - 12.2.3 Operating Flexibility
  - 12.2.4 Location Flexibility
  - 12.2.5 Scale Economies
  - Self Assessment Questions
- 12.3 Outsourcing in Warehousing**
  - 12.3.1 Outsourcing Decision
  - 12.3.2 Choosing the Right Partner
  - 12.3.3 Third-Party Contractors
  - 12.3.4 Why Contracts Fail
  - 12.3.5 Future of Outsourcing
  - Self Assessment Questions
- 12.4 Summary**
- 12.5 Key Words**
- 12.6 Case Study**
- 12.7 Exercise**
- 12.8 Answers for Self Assessment Questions**
- 12.9 Suggested Books and e-References**

**LEARNING OBJECTIVES**

*After studying this chapter, you will be able to:*

- Explain the factors to be considered in warehousing strategy
- Discuss how to take an outsourcing decision for a warehouse
- Describe how to choose the right partner or third-party contractors for outsourcing
- Elaborate on why contractors fail
- Describe the future of outsourcing

**12.1 INTRODUCTION**

In the previous chapter, you studied various health and safety issues in warehousing. You also studied the types of risk assessment that can be performed with respect to the layout and design of the warehouse, fire safety, slips and trips, manual handling and people working at heights. The chapter also discussed first aid, health and safety arrangements, and warehouse employee occupational health and safety.

An organisation has to formulate effective strategies for business growth. A strategy implies an action plan that is formulated to achieve a long-term or overall aim. Similarly, an organisation has to employ a sound warehousing strategy to reduce the overall logistics cost and stay competitive in the market. For example, an organisation can maintain its own warehouse or can outsource warehousing functions to a logistics service provider. Many organisations use a combination of private, public and contract warehouses.

In this chapter, you will study various factors that need to be considered while creating a warehousing strategy. There will be a discussion on warehouse outsourcing. You will understand how to take a warehousing decision and select the right partner or the third-party contractor. You will also get acquainted with the reasons for the failure of contracts and the future of outsourcing.

**12.2 FACTORS TO BE CONSIDERED IN A WAREHOUSING STRATEGY**

A warehousing strategy signifies selecting the right geographic sites and the number of warehouses required to achieve a place and time utility while enhancing the impact of sales and marketing in terms of total cost reduction and increased market dominance.

Most organisations use a combination of public, private and contract warehouses. A contract or private warehouse is used to handle the basic yearly needs while a public warehouse is used for peak season requirements. In some scenarios, field or market warehouses are public warehouses while central warehouses are private ones. One can use contract warehouses in either case.

The utilisation of an entire warehouse completely is rare to achieve. According to a planning rule, warehouses that are designed to be used in their full capacities are actually used from 75%-85% of the entire time. Therefore, 15%-25% of the time, the warehouse space required for meeting the peak season needs is not used. In

such scenarios, building private warehouses is more efficient for covering 75% of the needs and the remaining needs can be adjusted by using a public warehouse.

Another form of combined public warehousing can be the output of market needs. An organisation can discover that this type of warehousing is more suitable at particular locations depending upon the volume of distribution. However, in other types of markets, public warehouses can prove to be the least costly. The aim of the logistical system design is to analyse the type of warehouse combinations and strategies for meeting customer demand.

There are two main issues upon which an integrated warehouse strategy focusses. They are:

- The number of warehouses to be used
- The type of warehouses required for meeting the market needs

Most organisations can address these issues by using a combination of warehouses, depending upon the product and customer types. In some cases, customers are best served through a public warehouse, while in others, a private warehouse is the best option.

In the supply chain management, a warehouse is an important element. The decisions to set up the related facilities need to be determined by the overall strategies of the supply chain for cost and service. A warehouse fits into a strategic system design if it can provide either cost or service benefits. The selection of right locations for warehouses and their number is based on a number of factors, such as product needs, number of customers and manufacturing locations. A warehouse represents a part of an organisation's overall effort of gaining place and time utility.

The formulation of a warehouse strategy largely depends upon the overall objectives of an organisation with respect to the growth that the organisation expects in the future, especially with respect to the following factors:

- Level of desired and offered customer service
- Availability of products for customers
- Minimum cost of product distribution

Once the supply chain and corporate objectives are properly defined, it is important to consider current environmental factors with respect to customers' buying patterns, customers' demand patterns, competitors' warehousing strategies and customers' reactions in case of stockout.

Once the environmental scenario is analysed, one needs to analyse the organisation's resources with respect to brand equity, warehouse facilities needed for products and the availability of finances and other required resources.

Warehouse strategists perform all the above steps for a comprehensive analysis of the entire situation which allows them to take decisions with respect to the following:

- Warehousing cost
- Warehouses' locations

**NOTES**

- Whether to have a private warehouse or outsource a public one
- Whether to have a centralised or decentralised warehouse if the organisation has a private warehouse

An all-inclusive study has been done for public and private warehouses which allows warehouse strategists to make a decision on the ownership of warehouses. The warehouse strategists can consider on the specific warehouse type while taking decisions. These factors are presence synergies, industry synergies, operating flexibility, location flexibility and scale economies.

Five qualitative decision factors are shown in Figure 1:

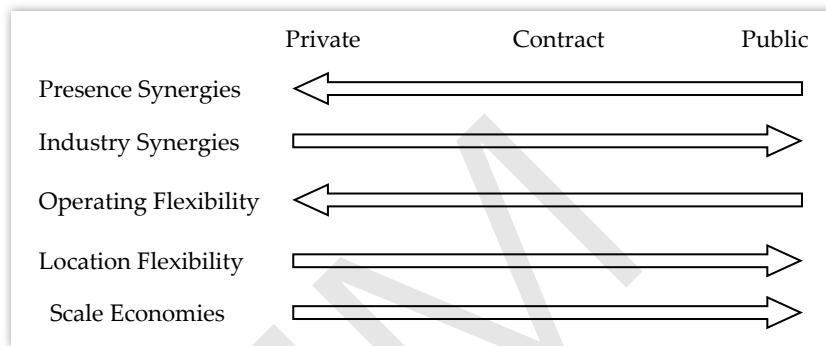

**FIGURE 1: Qualitative Decision Factors for Warehousing**

We will discuss these factors in detail in the next sections. With respect to the number of warehouses, organisations need to achieve their logistical and marketing objectives. Generally, the following two options are available:

- Centralised warehouses
- Decentralised warehouses

If an organisation has a very few warehouses for distributing its products, they are called centralised warehouses. On the other hand, if the number of warehouses is more, they are called decentralised warehouses. Generally, centralised warehouses are built around a site of production and they have a few points of dispatch. Centralised warehouses are used by organisations that need centralised inventory control, like the ones with a limited market, high unit prices, strong brand loyalty and industrial products. In contrast to centralised warehouses, decentralised warehouses are generally built around market areas and have multiple points of dispatch. These warehouses are used by organisations that need customer responsiveness, such as Fast-Moving Consumer Goods (FMCG) sectors and retail chain stores.

Table 1 shows the strengths and weaknesses of both types of warehouses:

**TABLE 1: Strengths and Weaknesses of Centralised and Decentralised Warehouse**

Strengths of a centralised warehouse	Strengths of a decentralised warehouse
Centralised inventory control exists. No stock out conditions due to goods storing at one or a few locations.	There is a better control over market intermediates.

Strengths of a centralised warehouse	Strengths of a decentralised warehouse
Warehousing costs are less. Transportation done in bulk is relatively cheaper.	There is maximum market coverage which results in more sales.
There is no need to carry a large inventory as done in decentralised ones.	As a result of maximised customer service, high levels of goodwill and loyalty are achieved.
The demand for various market segmentations can be met even in a short span of time.	Transportation costs are moderate while performing bulk transportation from a plant to a warehouse.
Weaknesses of a centralised warehouse	Weaknesses of a decentralised warehouse
The advantage of customer service is lost.	Stockout situations occur.
Market control and coverage is poor.	High investment is involved in inventory.
Unless done in bulk, transportation costs are high.	The development costs of warehouses are high.
Demands from distant markets cannot be completed on short notice; otherwise, costly transportation modes are used.	Additional transportation costs are needed if there is a shortage of goods in one warehouse that needs to be replenished from another.

Irrespective of the type of a warehouse, warehouse strategists need to consider the following factors to select the location of warehouses and decide on their number:

- **The number of locations of markets that are targeted by the organisation:** If the product markets of an organisation are clustered and limited, the location of its warehouses should be near markets and the number of warehouses should be limited. In addition, if the markets' locations are near to the organisation's production plant, it is better to work from the in-plant warehouse. If markets are diversified and wide, the organisation should use decentralised warehouses.
- **Corresponding facilities and locations of production centres:** The number of production plants the organisation has and their distances from the potential and target markets is another factor that helps in determining the location and number of warehouses. If the organisation has various production plants that are close to various target markets, it is better to operate in plant warehouses. Production centres' facilities deal with products that are produced by the organisation as single, multiple or all products. If all the production centres produce all products of the organisation, warehouses are not needed. This is because, in that case, production centres can be also used as distribution centres. If some specific or different products from the organisation's total product mix are produced by various production centres, which are close to the markets and geographically widespread, then again the organisation does not need warehouses. However, if none of the above situations is true, a decentralised distribution warehouse is needed.
- **Transportation infrastructure facilities:** This factor comprises the availability of quality vehicles capable of transporting goods in the desired quantity, realistic costs of transportation and transit time. In such cases, the organisation can use centralised warehouses, otherwise, it needs to use decentralised ones.
- **Financial resources:** If an organisation has financial constraints or is not wealthy enough, it should use public warehouses. The reason is that it needs minimum finance and capital to use public warehouses.

## NOTES

- **Quantity, quality and nature of goods to be stored:** This is another factor that has an impact on the warehousing strategy. For example, for a specific time period, highly seasonal products are required to be stored in bulk. For situations like this, the organisation should use decentralised warehouses.
- **Possibility of change in warehouse use:** If there is a possibility that the organisation might change the use of its warehouse later, the organisation should make a plan for that possibility. For example, an organisation can consider whether it is profitable to lease the warehouse or sell it to the other party.
- **Management philosophy with respect to customer service use:** If the organisation's management decides to utilise customer service to gain a competitive advantage, the organisation should have decentralised warehouses that are located near the market. This will help serve customers in a better way and maintain market dominance.

Many organisations have found that to give better customer service, an effective way is to create regional warehouses or hubs to store products in Semi-Knocked Down (SKD) conditions and deliver them after assembling when an order has arrived. This technique works fairly well for the computer hardware and automobile industries.

For example, Hyundai has a warehouse near Chennai, which is close to its factory, and has two more warehouses in Mumbai and Delhi to stock spare parts. Using these warehouses, Hyundai has developed access to markets, such as Aurangabad and Ludhiana. Therefore, if an Aurangabad customer needs anything, he/she can approach the Mumbai warehouse instead of waiting for the product to arrive from Chennai.

After getting the general view of the warehousing strategy, let us now talk about the five qualitative decision factors which need to be considered while developing warehousing strategies. The qualitative decision factors are discussed in the following subsection.

### 12.2.1 | PRESENCE SYNERGIES

Presence synergies imply the benefits of marketing when the warehouse inventory is situated in a nearby building which is clearly associated with the organisation. This means that the warehouse building has the name of the organisation on it. As per a widespread notion, when the supplier maintains inventory in nearby locations, customers feel more comfortable. Customers and products benefitting through the local presence need to be served using contract or private warehouses.

### 12.2.2 | INDUSTRY SYNERGIES

Industry synergies are the operating benefits that come from the collocation with other organisations that are dealing in similar products and belong to the industry. For instance, organisations dealing in grocery are generally benefitted when their public warehouses are shared with other suppliers that deal in the same industry. The transportation costs are less too which is one of the key benefits because the combined use of the same warehouse results in quick delivery of combined loads from various suppliers. Contract and public warehousing results in an increase in industry synergy potential.

### 12.2.3 | OPERATING FLEXIBILITY

Operating flexibility means the capability of adjusting to the internal procedures and policies for meeting customer and product requirements. Private warehouses run under the organisation's control and, therefore, generally, they are perceived to show more operational flexibility. However, public warehouses generally deploy procedures and policies that are common for all their customers for minimising any confusion with respect to their operation. Various contract and public warehouse operations also show great responsiveness and flexibility.

### 12.2.4 | LOCATION FLEXIBILITY

Location flexibility infers the capability of adjusting the number and locations of warehouses quickly as per the changes in the permanent and seasonal demands. For instance, seasonal demands for chemicals used in agriculture require warehouses to be situated near market areas as they facilitate a quick pickup by customers. In the non-crop season, it is not necessary to have local warehouses. Therefore, the desired strategy is to be capable of opening and closing local warehouses on a seasonal basis. Contract and public warehouses provide the location flexibility to implement this strategy.

### 12.2.5 | SCALE ECONOMIES

Scale economies imply the capability of reducing storage and material handling with the use of advanced technologies. Generally, there is a great opportunity for high volume facilities to obtain these benefits, as they can easily spread the fixed cost of technology over large product volumes. Additionally, in the case of automated equipment, capital investment can help in reducing the direct variable cost. Generally, contract and public warehouses are considered to provide better scale economies as they can design warehouses and operations for meeting high volume demands received from various customers.

#### SELF ASSESSMENT QUESTIONS

1. \_\_\_\_\_ infers the capability of adjusting the number and locations of warehouses quickly as per the changes in the permanent and seasonal demands.
2. In supply chain management, a warehouse is the least important element. (True/False)

#### ACTIVITY

Visit a warehouse and find out which type of warehouse is it. Interview the staff and note the factors they have considered to select the warehouses' location and numbers. Prepare a report based on your observations.

## 12.3 | OUTSOURCING IN WAREHOUSING

Outsourcing is described as the act of working with a third-party vendor or supplier for providing a service or function that is not a part of the core competence of the

## NOTES

organisation. As per a famous quote by Peter F. Drucker, “*Do what you do best and outsource the rest.*” The crux is to take the benefit of the knowledge and economies of scale of the supplier for improving the organisation’s performance and getting the required service. This generally happens at a lower cost but not always.

There are many reasons why organisations choose to outsource their warehousing operations to a third-party specialist. These relate to the obvious justification of reduced capital investment and savings on buying warehouse equipment, and reduced requirement of hiring special warehousing staff. These also include some quantifiable and tangible benefits of flexibility.

The top ten reasons for outsourcing warehouse operations are listed in Figure 2:

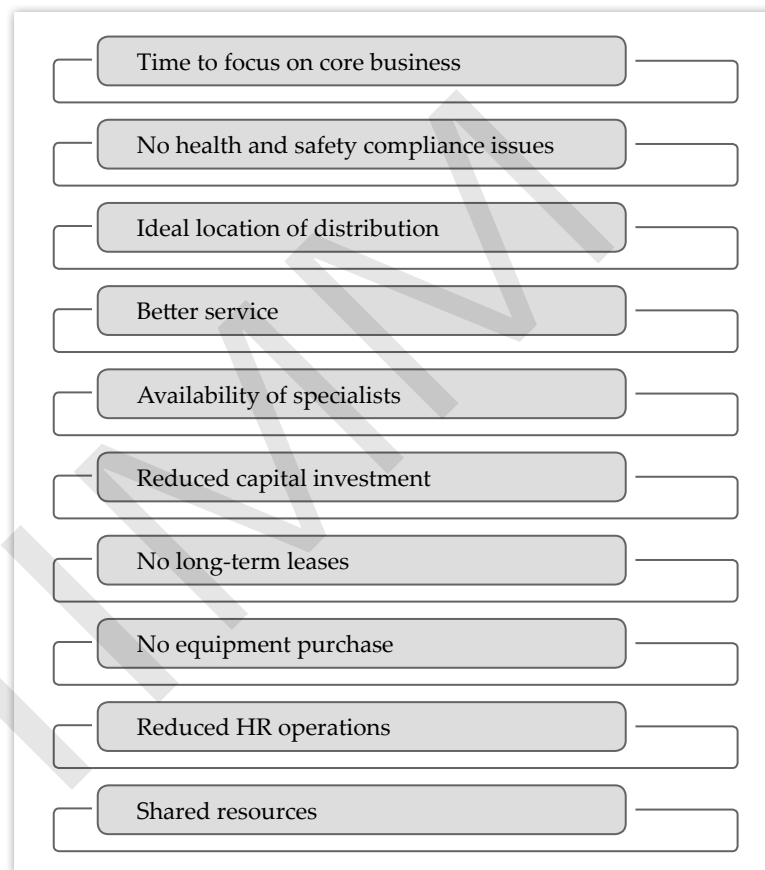

FIGURE 2: Reasons for Outsourcing

Let us now briefly discuss the top ten reasons for outsourcing warehouse operations which are listed as follows:

- **Time to focus on core business:** If an organisation is dealing in import, export, retail or a similar sector, such as agriculture, that just needs storage space, some business consultants may say that it is not a warehouse business. In such cases, business operations are non-core and the feasibility of outsourcing is more, especially in those cases, where warehouse operations are not earning revenue directly. Also, when overheads are considered, such operations need the time and expertise of management along with money. If outsourcing is done in such cases, these resources can be put to better use in direct activities of the organisation’s business.

- **No health and safety compliance issues:** Running and managing a warehouse can be a really complex task as it requires due consideration of health and safety needs. It is critical and mandatory for an organisation to train and certify its staff on warehousing operations. This training is subject to rigorous enforcement.

Health and safety issues can be clumsy when they are completely justified. Some organisations also see such issues with red flags, although these are related to legal compliance. These are the reasons why all warehousing functions should be outsourced to third-party specialists.

- **Ideal location of distribution:** In an import business, one of the key priorities is to keep the road miles to the minimum. This implies getting products to the warehouse as cheaply as possible after passing through all ports of entry. Therefore, it is sensible to choose a warehouse that provides easy accessibility to the required ports.

If organisations have selected a warehouse that is flexible in its services' offer, it can also provide distribution operations. In such cases, the provider can also perform goods management and distribution for the organisation which leads to more operational benefits.

- **Better service:** Special third-party warehouse operations suppliers with their revenues depending upon the provisions of warehousing are generally experts in their fields. Such warehouse providers give services at a very high level that is supported by performance agreements under a contract. Due to these agreements, provisions are enforced not only in a legal context but the provider also works hard for retaining business. Therefore, it is a key priority for the warehouse providers to give excellent services for keeping the organisation's business up and running.
- **Availability of specialists:** There is an old adage that if a third-party supplier can work better, then it is worth examining the outsourcing options. If no plausible outsourcing reason appeals to the organisation, then the organisation can start analysing the current cost of its warehousing operations and compare them against the specialists' cost.
- **Reduced capital investment:** This is one of the key reasons why warehousing operations should be outsourced. It is viable for organisations to own a private warehouse or take warehouse space on rent. The costs of managing a warehouse as part of organisations' business are generally high in comparison to outsourcing.

Outsourcing is a definite answer if it is just a matter of outsourcing vs. ownership, where cash flow and costs are the sole factors. The capital cost can be freed up if one switches from in-house warehousing to outsourced warehousing. The upfront cost can also be avoided completely if one prefers outsourcing one's warehouse operations to a third-party vendor rather than investing in one's own warehouse.

- **No long-term leases:** Another main reason why organisations outsource their warehouse operations is lease terms flexibility. If products are seasonal in nature or the demand for the products is not constant, it would be prudent to outsource warehousing.

NOTES

If organisations outsource their warehouse operations to a suitable warehouse service provider, organisations get access to storage, such as pallet warehousing, along with other equipment and services that they can use as per the requirement.

- **No equipment purchases:** By availing the warehouse outsourcing option, organisations make huge savings on equipping warehouses with equipment, such as safety barriers, pallet racking, forklift trucks and mezzanine floors. The cost associated in buying and maintaining these equipment is high. Organisations can curtail the costs of these capital items by outsourcing warehouse activities.
- **Reduced HR operations:** Managing the warehouse staff can be an issue too, especially if warehouse operations are running all the time. When outsourcing the warehousing aspect, organisations also outsource all other aspects associated with warehousing, such as HR management, which include payroll, employee training, holiday pay and performance management.
- **Shared resources:** Shared resources are usually cost-efficient as the warehouse spreads overheads across various customers. By sharing warehouse resources, the quality of operations, such as pick/pack, storage and forwarding is not compromised, as the supplier is aware of the fact that his/her business is dependent on how well the organisation's business performs.

**12.3.1 | OUTSOURCING DECISION**

McIvor proposed a model that explains a process which organisations can consider while deciding upon outsourcing. He suggested that key areas that are required to be analysed are whether it is a core business activity, whether the partner is compatible and capable and whether the possible cost savings are substantial enough for making warehouse outsourcing possible. McIvor model outsourcing decision is shown in Figure 3:

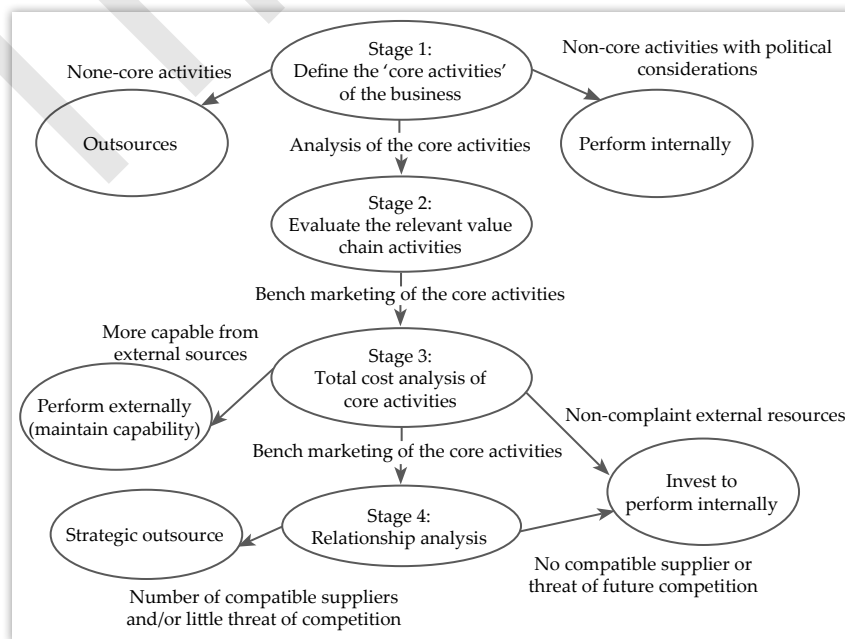

**FIGURE 3: McIvor Model Outsourcing Decision**

**Source:** *Warehouse Management: A Complete Guide to Improving Efficiency and Minimizing Costs in the Modern Warehouse*

In 2010, Vitasek added another dimension of whether the vendor has core competence or expertise in the related field that can create value for the organisation beyond the market offerings. The outsourcing decision matrix is depicted in Figure 4:

Potential value to the organisation	High	Partnership outsourcing approach	Core activity. Do not outsource!
	Low	Transactional outsource	Decision based on financial considerations
		Low	High
		Organisational expertise	

FIGURE 4: Vitasek's Outsourcing Decision Matrix

The objective is to keep the work in house for organisations that lack the expertise of warehousing. The top five reasons of why organisations do not outsource are as follows:

- Cost reduction not expected
- Logistics being a core competency of the organisation
- Expected service levels not realised
- Logistics being too critical to consider outsourcing
- Corporate philosophy does not include outsourcing

The decision of outsourcing warehouse operations should depend on the following factors:

- The culture and profile of the possible supplier
- The appropriateness of the activities being outsourced
- The effect of outsourcing on the rest of the organisational activities

### 12.3.2 | CHOOSING THE RIGHT PARTNER

It can be tricky to select a third-party logistics provider. Organisations looking to outsource their warehouse operations should be well prepared with the right kind of information before deciding anything. Any business that deals in various Stock Keeping Units (SKUs) and various customer orders each day understands the importance of logistics and the fact that logistics can be more complex than mere putting the stuff onto shelves. For organisations of all sizes, from a local pharmaceutical to a multi-million dollar cosmetic organisation, managing inventory is a key business challenge.

## NOTES

Third-party logistics includes transportation, services and storage that allow organisations to deliver customer goods. The other services offered by third-party logistics organisations include cross-docking, RFID tagging, labelling and copacking.

When an organisation is looking for an external warehouse for outsourcing, it is important to consider some abilities that should meet the organisations' business requirements. The outsourced organisation should have the right experience and capability in the industry. It should be an outsourced organisation whose core competency is to provide warehousing facilities rather than a transport organisation that provides warehousing as an add on. Additionally, it should offer effective supply chain services at affordable rates.

*Bititci et al* (Director of Center for Strategic Manufacturing and professor at the University of Glasgow) suggested that the following factors should be considered when selecting the right partner:

- **Operational synergy:** The possible fit of the applicable processes of the partner organisation is in alignment with the client organisation.
- **Strategic synergy:** The possible fit of the strategic priorities and business model of the partner organisation are in alignment with client organisations.
- **Cultural synergy:** The cultural fit between the two organisations at the operational and strategic levels is strong.
- **Commercial synergy:** The nature of risk management, service level and commercial agreements between both organisations are aligned.

After deciding the criteria, one can weigh the importance and then score every organisation against those criteria. From organisation to organisation, the criteria will vary along with their weighing. Table 2 illustrates an example of such a comparison:

TABLE 2: Decision Matrix of Outsourcing

Category	Target Rating	Weight	Target Score (Target Rating × Weight)	Rating 3PL (A)	Actual score [Rating 3PL (A) × Weight]
Market Experience	4	30	120	1 2 3 <u>4</u> 5	120
Range of Services	5	40	200	1 2 <u>3</u> 4 5	120
Health and Safety Records	5	30	150	1 2 3 4 <u>5</u>	150
Total Cost	4	30	120	1 2 3 4 <u>5</u>	150
Management Quality	5	30	150	1 2 3 4 <u>5</u>	150
Strategy	4	20	80	1 2 <u>3</u> 4 5	60
Financial Stability	5	10	50	1 2 <u>3</u> 4 5	30
Information Technology	5	20	100	1 2 3 4 <u>5</u>	100
Global Coverage	5	10	50	1 2 3 4 <u>5</u>	50
Reputation	5	10	50	1 2 3 <u>4</u> 5	40

Category	Target Rating	Weight	Target Score (Target Rating × Weight)	Rating 3PL (A)	Actual score [Rating 3PL (A) × Weight]
Shared User/Public Warehouses	5	10	50	1 2 3 4 <u>5</u>	50
<b>Total Score</b>			<b>1120</b>		<b>1020</b>
<b>Measurement Index</b>					<b>91.1% Fit</b>

*Source: Warehouse Management: A Complete Guide to Improving Efficiency and Minimizing Costs in the Modern Warehouse*

### 12.3.3 | THIRD-PARTY CONTRACTORS

Third-party contractors can work as shared users and undertake warehouse operations on behalf of their clients. In the case of shared user warehousing, a third-party logistics organisation acquires a warehouse facility and utilises it to offer various services on behalf of various customers that manufacture various products.

In the case of dedicated warehouses, the organisation decides to either renounce its own operations of warehousing to an external party that overtakes the equipment, staff and building or to start a new operation with outsourcing and not run the warehouse by its own. This can be the utilisation of an existing facility or new construction.

In addition, warehouses can run as fulfilment centres in which various mail orders or e-commerce customers are housed in the same facility with similar kinds of services. Other shared warehouses may run on organisations' behalf that manufacture a similar type of products. Manufacturers see the advantages of synergy, though competing with others, for their products getting stored and delivered from the same warehouse through the same channels of distribution.

The staff employed in warehouses is experienced with handling the products and delivery costs to retail outlets. Manufacturers can share these costs. In a different variation, retail consolidation warehouses exist. In these warehouses, products from the cross-dock and suppliers store of the retailer are directed to the store or distribution centre of the retailer. One can operate these centres by third-party organisations or in house.

### 12.3.4 | WHY CONTRACTS FAIL

When an organisation outsources its warehousing operations, it does not mean that the organisation can run away from all operational tasks and responsibilities. The entire success depends upon how well an organization, along with the outsourcing organisation, works together for ensuring that the initial objectives are met. In such relationships, the key is to have trust and openness.

Warehouse outsourcing is generally dependent on a transactional relationship and it can, therefore, result in a confrontational one. In the traditional type of outsourcing, the customer seeks to improve service levels and reduce costs, while the contractual organisation seeks to maximise profits and increase the contract size.

## NOTES

Various reasons due to which contracts with third party fail are depicted in Figure 5:

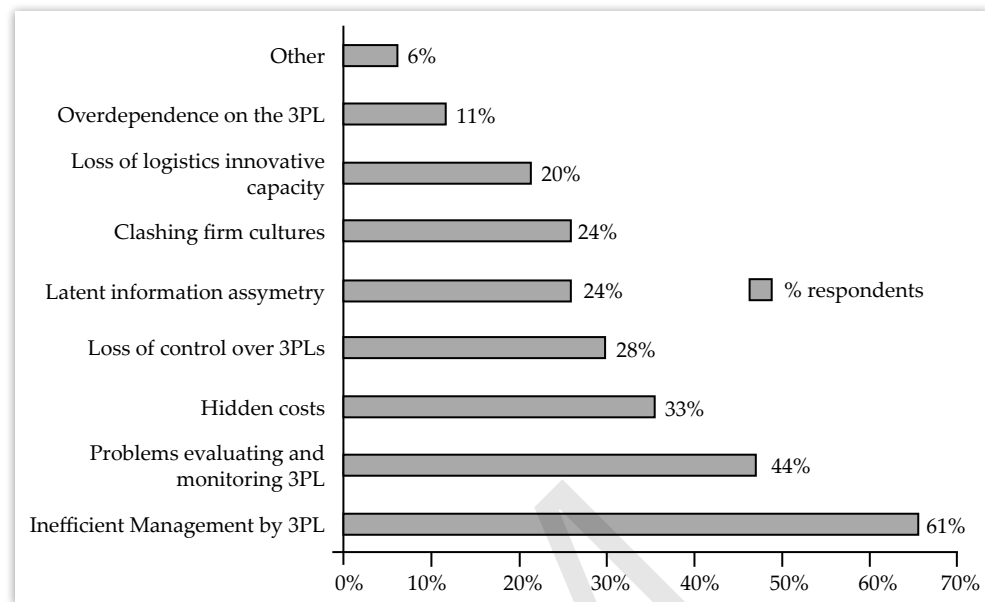

**FIGURE 5: Reasons Why Contracts Third-Party Logistics Organisations Fail**

**Source:** *Warehouse Management: A Complete Guide to Improving Efficiency and Minimizing Costs in the Modern Warehouse*

The reasons for not renewing contracts were as follows:

- Poor service levels
- Availability of cheaper competitors
- Trust loss
- Unwillingness to change during the period of contract
- Higher cost as compared to what was predicted
- Rates hike during the period of contract
- Non-delivery of promised flexibility
- Contract terms not delivered
- Lack of commitment

### 12.3.5 | FUTURE OF OUTSOURCING

The book 'Vested Outsourcing: Five Rules that Will Transform Outsourcing (2010)' by Kate Vitasek provides valuable insights into the future of warehouse outsourcing. According to Vitasek, service improvement, cost reduction and overall profits can be enhanced with the help of greater values and collaboration. If organisations adopt What's In It For We (WIIFWe) mindset, it can be useful for third-party logistics organisation and client (organisation). He suggests that both organisations should work on a business model by which they can maximise their benefits. This implies working in a culture in which both organisations work together for making the end-to-end process effective, irrespective of which organisations are performing the tasks.

This implies moving away from the traditional approach to a more collaborative and outcome-based one. The model by Vitasek from confrontation to collaboration is depicted in Figure 6:

The model by Vitasek from confrontation to collaboration explained in Figure 6:

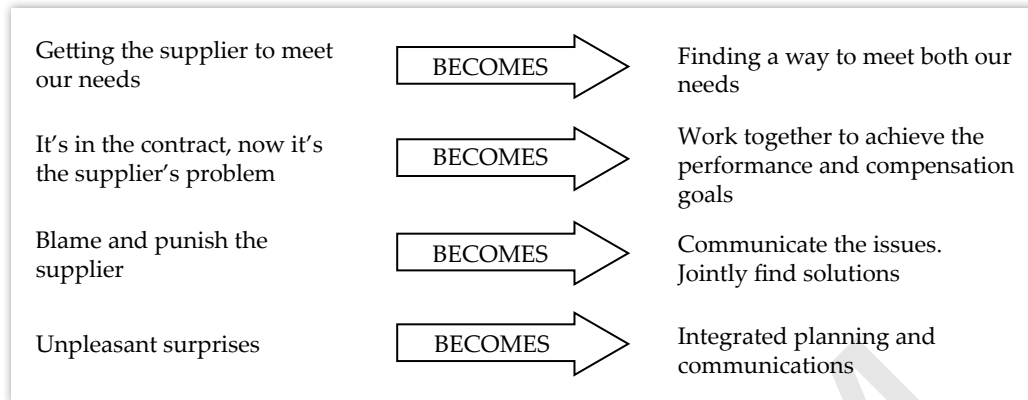

FIGURE 6: Vitasek Model from Confrontation to Collaboration

As per the approach suggested by Vitasek, an increase in cost results in benefits for the logistics provider unless there are appropriate rewards and targets and a reduction in the margin for bad performance.

Five rules of a successful outsourcing partnership are shown in Figure 7:

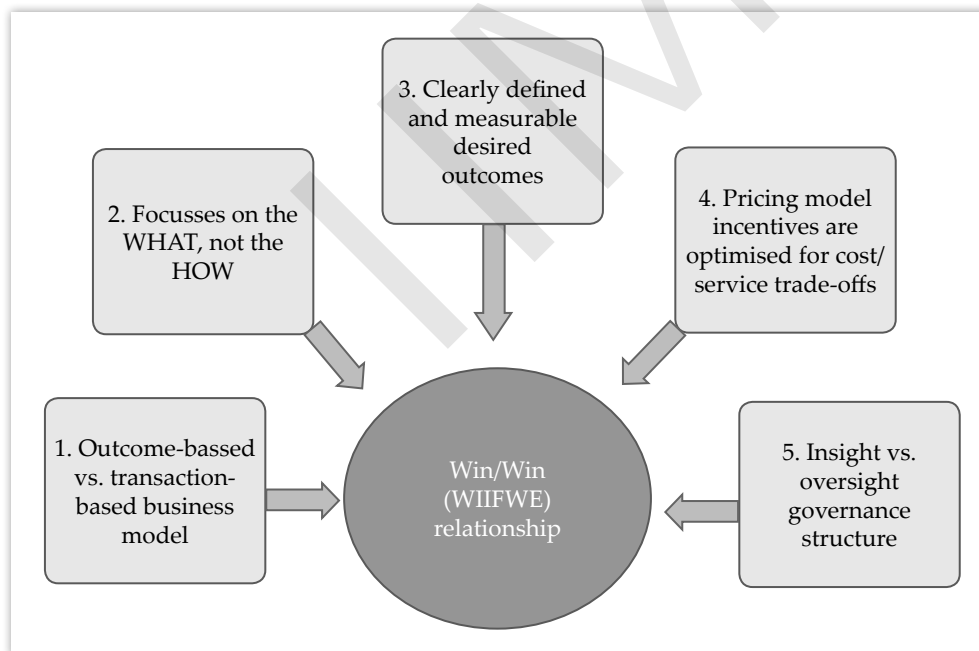

FIGURE 7: Five Rules of Successful Outsourcing Relationship

This implies moving away from transactional payments to vendors for innovation and outcomes. The idea is that with innovation, the customers' money is saved while service levels are improved. As a result, the provider increases the customer's confidence and gets more work in return, which ultimately results in increased margins and revenues.

**SELF ASSESSMENT QUESTIONS**

3. \_\_\_\_\_ contractors can work as a shared user and dedicated warehousing on their customers' behalf.
4. Running and managing a warehouse can be a really complex task as it requires due consideration of health and safety needs. (True/False)
5. Match the following:

List 1	List 2
1. Outsourcing	a. The capability of adjusting to the internal procedures and policies for meeting customer and product requirements
2. Decentralised warehouses	b. Aims to analyse the type of warehouses combinations and strategies for meeting customer demand
3. Logistical system design	c. The benefits of marketing when the warehouse inventory is situated in a nearby building, which is clearly associated with the organisation
4. Presence synergies	d. The act of working with a third-party vendor or supplier for providing a service or function that is not part of the core competence of the organisation
5. Operating flexibility	e. Used by organisations that need customer responsiveness, like Fast Moving Consumer Goods (FMCG) sectors and retail chain stores

- |                            |                            |
|----------------------------|----------------------------|
| a. 1-d, 2-c, 3-b, 4-a, 5-e | b. 1-d, 2-e, 3-b, 4-c, 5-a |
| c. 1-c, 2-e, 3-a, 4-d, 5-b | d. 1-e, 2-d, 3-a, 4-b, 5-c |

**12.4 SUMMARY**

- A warehousing strategy means the right geographic sites and the number of warehouses required to achieve place and time utility while enhancing the impact of sales and marketing in terms of total cost reduction and increased market dominance.
- Outsourcing is described as the act of working with a third-party vendor or supplier for providing a service or function that is not a part of the core competence of the organisation.
- The top ten reasons for outsourcing warehouse operations are time to focus on core business, no health and safety compliance issues, ideal location of distribution, better service, availability of specialists, reduced capital investment, no long-term leases, no equipment purchase, reduced HR operations and shared resources.

- McIvor proposed a model that explains a process that organisations can consider when deciding upon outsourcing.
- When an organisation is looking for an external warehouse for outsourcing, it is important to consider some abilities that should meet the organisation's business requirements.
- By sharing warehouse resources, the quality of operations, such as pick/pack, storage and forwarding, is not compromised as the supplier is aware of the fact that his/her business is dependent upon how well an organisation's business performs.
- The entire success is dependent on how well an organisation along with the outsourcing organisation work together for ensuring that the initial objectives are met. In such relationships, the key is to have trust and openness.
- Third-party contractors can work as shared user and dedicated warehousing on their customers' behalf.
- When an organisation outsources its operations, it does not mean that the organisation can run away from all operational tasks and responsibilities.
- In an import business, one of the key priorities is to keep the road miles to the minimum. This implies getting products to the warehouse as cheaply as possible after passing through all ports of entry.
- Warehouse outsourcing is generally dependent on a transactional relationship and it can, therefore, result in a confrontational one.
- In the traditional type of outsourcing, the customer seeks to improve service levels and reduce costs while the contractual organisation seeks to maximise profits and increase the contract size.

## 12.5 KEY WORDS

- **Warehouse strategy:** It means selecting the right geographic sites and the number of warehouses required to achieve a place and time utility while enhancing the impact of sales and marketing in terms of total cost reduction and increased market dominance.
- **Centralised warehouses:** They are built around a site of production and they have a few points of dispatch. They are used by organisations that need centralised inventory control, such as the ones with a limited market, high unit prices, strong brand loyalty and industrial products.
- **Presence synergies:** This refers to the benefits of marketing when the warehouse inventory is situated in a nearby building which is clearly associated with the organisation.
- **Location flexibility:** It infers the capability of adjusting the number and locations of warehouses quickly as per the changes in the permanent and seasonal demands.
- **Operating flexibility:** It implies the capability of adjusting to the internal procedures and policies for meeting customers and products.

## 12.6 CASE STUDY: OUTSOURCING WAREHOUSE OPERATIONS BY A FITNESS ORGANISATION

A prosperous organisation dealing in speciality outdoor fitness equipment anticipated the need to outsource its order fulfilment and warehouse activities. The reason was that the organisation's owner needed to spend the energy and time of its senior management on tasks, such as developing innovative and new products, that could help its market share flourish. The owner analysed that warehouse operation was not its core competency. Hiring experienced professionals to manage warehouse operations was not affordable as well. As a result, the accuracy of orders and on-time fulfilment of the order was suffering. Another challenge was to cover the warehouse cost during seasonal business and peak season. However, during the lean season, retaining the extra warehouse space was an expensive proposition. Therefore, the organisation's owner decided to outsource warehouse operations.

The outsourced organisation started to perform a detailed cost analysis. To the surprise of the owner, the analysis showed that considering compensation of workers, wage and salary accounts, material handling equipment, insurance, rent, general warehouse costs and other costs, the actual fully-loaded cost to run the warehouse was much more than what the owner actually realised. The outsourced organisation also recognised that those operational costs were expected to get higher because of the increasing costs of health insurance and the recently passed legislation on minimum wages.

On the basis of this cost analysis, the outsourced organisation aimed to reduce the order fulfilment and warehousing costs by 43%. It further aimed to enhance the metrics of customer services in a significant manner and prevent any future cost increase in health insurance and the minimum wage.

After making the decision of transitioning, the outsourced organisation created a comprehensive and detailed plan of transition in coordination with the operations team. As a result of some weekly meetings, a target cut-over date was decided. The transition plan comprises getting the SOPs from the client, requirements of electronic data interchange, routing guides, labelling and packaging requirements and item master uploads. The outsourced organisation integrated with the shopping cart platform of the client. As the next item, it planned to implement an effective strategy of slotting.

With the aid of the data received and analysed, the outsourced organisation allocated specific SKUs to the most suitable storage medium with respect to the product family. In the next step, products were located to picking locations on the basis of their velocity. This was done for maximising the labour.

After the cycle of planning and implementation, the transition phase ended and the warehouse started working again. It was ensured that the transition was smooth and the downtime was minimal for fulfilling new customer orders.

The outsourced organisation started reporting on a number of metrics, such as on-time delivery, order cycle times and accuracy of the inventory, which were determined in the initial stage. As a result of outsourcing its warehouse operations,

the parent fitness organisation gained better visibility on shipments, inventory, tracking and goods receipts.

In the end, the parent fitness organisation earned 40% cost savings on warehouse operations and also obtained current metrics for understanding the key indicators of customer satisfaction while their management team remained focussed on creating innovative and new products.

Source: *healthandsafetyatwork.com*

## QUESTIONS

1. What tasks did the owner of the organisation want his senior management to do?  
(Hint: To let the innovative and new products flourish in the market)
2. What was the warehousing problem faced by the organisation?  
(Hint: Inaccuracy of orders and problem with on-time fulfilment of orders)
3. Which additional challenge was encountered by the organisation?  
(Hint: To operate seasonal business and requirement of warehouse space during the peak season)
4. What all entailed in the transition process as proposed by the outsourced organisation?  
(Hint: Obtaining the SOPs from clients, electronic data interchange, etc.)
5. What were the results experienced by the organisation by the outsourcing of its warehouse operations?  
(Hint: Gained better visibility on shipments, inventory, tracking, etc.)

## 12.7 EXERCISE

1. What are the factors to be considered in the warehousing strategy? Explain.
2. Which factors do warehouse strategists need to consider while selecting the location of warehouses?
3. What are various reasons for outsourcing warehouse operations? Explain.
4. Explain how to choose the right partner for warehouse outsourcing.
5. Enumerate the reasons why contracts fail.

## 12.8 ANSWERS FOR SELF ASSESSMENT QUESTIONS

Topic	Q. No.	Answer
Factors to be Considered in a Warehousing Strategy	1.	Location flexibility
	2.	False
Outsourcing in Warehousing	3.	Third-party
	4.	True
	5.	b. 1-d, 2-e, 3-b, 4-c, 5-a

## 12.9 SUGGESTED BOOKS AND E-REFERENCES

### SUGGESTED BOOKS

- Richards, G. *Warehouse Management*. (2016)
- Keller, S., & Keller, B. (2013). *The Definitive Guide to Warehousing*.

### E-REFERENCES

- Stringfellow, A. (2019). 8 Reasons to Outsource Your Warehousing Operations-Wonolo. Retrieved 12 December 2019, from <https://www.wonolo.com/blog/8-reasons-to-outsource-your-warehousing-operations/>
- 10 Reasons to Outsource Your Warehousing. (2019). Retrieved 12 December 2019, from <https://www.masterslogistical.co.uk/the-top-10-reasons-to-outsource-your-warehousing>

## About IIMM

“Indian Institute of Materials Management (IIMM)”, with its headquarters at Navi Mumbai, is a Professional Body of Materials Management classified under Engineering & Technology Group under Apprenticeship Act, 1961 and is recognised by ISTE, MHRD.

Through its wide network of 52 branches and 19 chapters having around 9500 members drawn from public and private sectors, IIMM is dedicated to the promotion of the profession of Materials Management through its multifarious activities including Educational Programs approved by AICTE (Post Graduate Diploma in Materials Management and Post Graduate Diploma in Supply Chain Management & Logistics), Seminars, National Conferences, Regional Conferences, Workshops, In-house training programs, Consultancy & Research Programs.

To have an effective global interaction, the Institute is a charter member of International Federation of Purchasing and Supply Management (IFPSM), Atlanta (USA) which has its roots in over 44 member countries.

In furtherance of its objectives, IIMM brings out a monthly journal, “Materials Management Review” comprising latest Articles and Research Papers in the field of Materials, Logistics, Purchase, Inventory, Supply Chain Management and latest Technological Innovations like Artificial Intelligence, Block Chain, Cloud Computing and Internet of Things.

The Institute has its Centre for Research in Materials Management (CRIMM) at Kolkata, which is engaged in promotion of research activities in collaboration with industries for furthering the advancement of the profession of Materials and Supply Chain Management.

The Institute is dedicated for the Societal & Environmental considerations through Sustainable Procurement, Green Purchasing and Life Cycle Consideration, which are part of our course curriculum. The aim & objective of the Institution is to update & upgrade the skills & knowledge of professionals so as to ensure inclusive and sustainable development.



### **Indian Institute of Materials Management**

Plot No. 102 & 104, Sector-15,  
Institutional Area, CBD Belapur, Navi Mumbai – 400614  
Ph.: 0222 757 1022/0222 756 5592,  
E-mail: iimmedu@iimm.co.in, Website: iimm.org